

ENERGY RECOVERY VENTILATORS

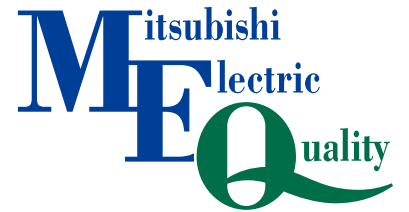

MODEL

RVX SERIES

State-of-the-art Lossnay heat exchange technology, reduces CO₂ and saves energy.

**MADE
IN
JAPAN**

Indoor air quality inside a building is optimised through

Lossnay is a total heat exchange ventilation system that uses paper characteristics to perform temperature (sensible heat) and humidity (latent heat) exchange.

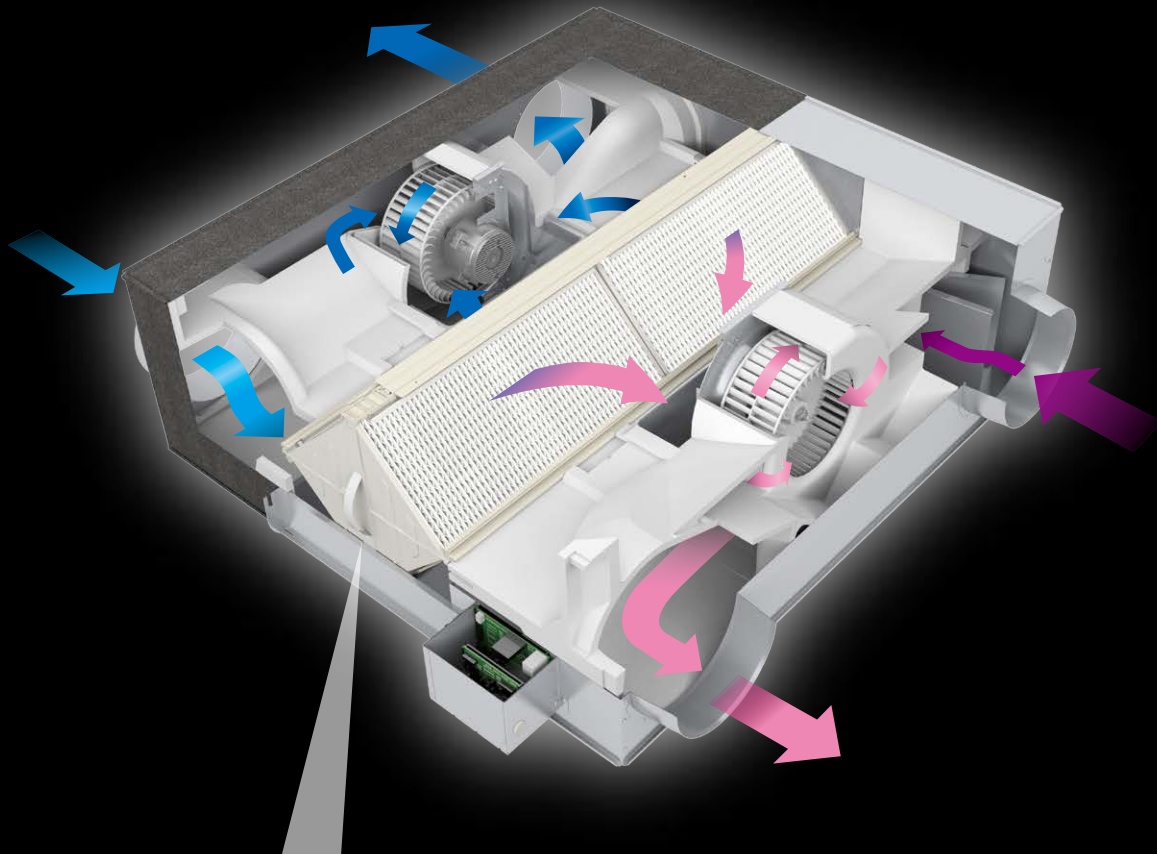

■ The concept of sensible heat and latent heat exchange using Lossnay core

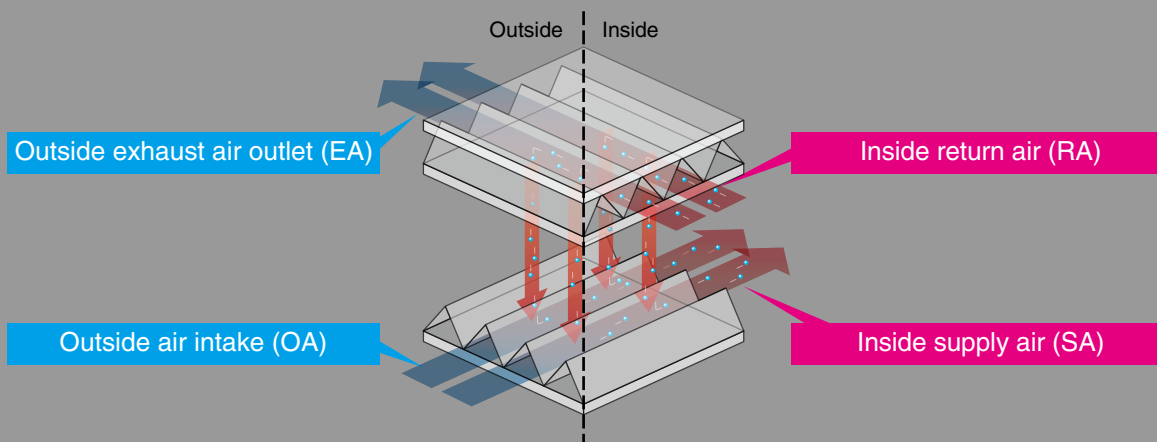

After launching its first generation in 1970, Lossnay has evolved by always looking ahead of the air conditioning needs of the times, which continue to diversify.

The technology is used in a wide range of applications and units have been widely adopted in residences, office buildings, hospitals, schools, etc.

temperature and humidity exchange by Lossnay

The need for ventilation

The need for fresh air

Poor air quality can be attributed to many problems arising in the workplace and in the home. It is believed to contribute to a significant loss in productivity, low morale and higher rates of sickness. Providing good ventilation in residential and commercial buildings is to provide conditions under which people can live and work comfortably and safely.

Effect of oxygen deficiency on human body

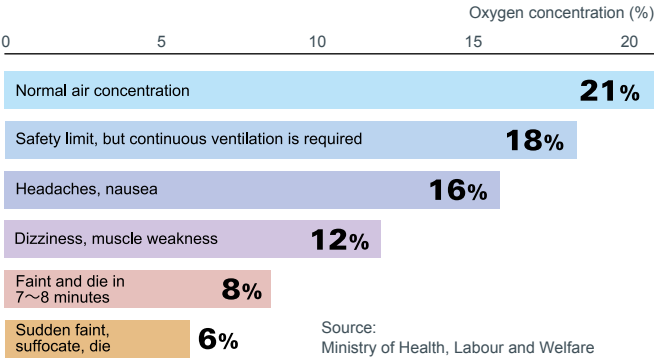

The need for appropriate humidity management

Viruses such as influenza are found to be active and the survival rate high in low humidity and dry environments.

In general, the survival rate is said to decrease significantly when the relative humidity is 50% or more the temperature is 20°C. During the winter, keeping an appropriate humidity and heating temperature can help prevent influenza.



Influenza virus survival rate

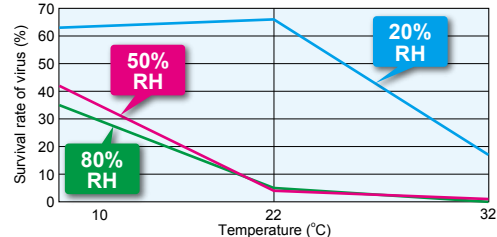

Source: Survival rate after 6 hours by G.J. Harper, Takehito Takano and other "Health Housing Science Seminar"

Activity range of microorganisms by humidity range

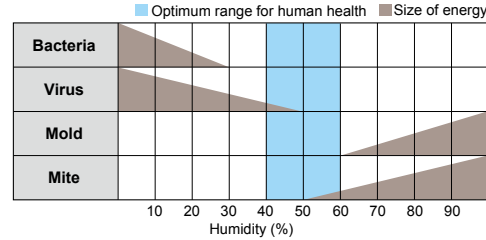

Source: ASHRAE Trans. 91 - 1B (1985)

What can be improved by introducing Lossnay?

Ventilation with maximised comfort

In summer

Air similar to the conditions of the cooled (dehumidified) indoor air is supplied.

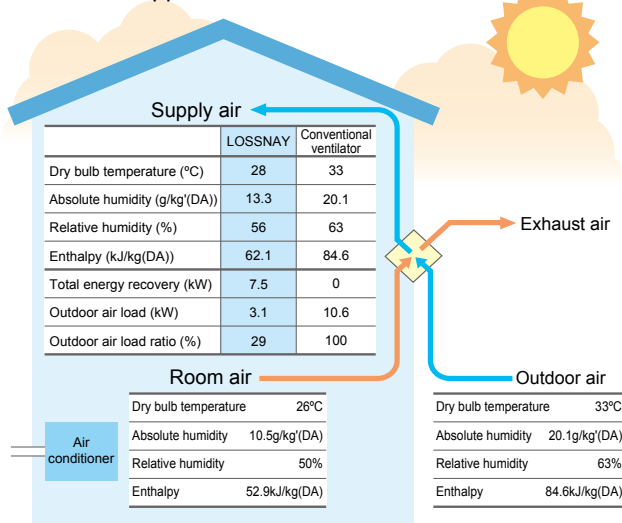

Heat recovery calculation

$$\text{Indoor supply-air temperature (°C)} = \text{Outdoor temperature (°C)} - \left(\text{Outdoor temperature (°C)} - \text{Indoor temperature (°C)} \right) \times \text{Temp recovery efficiency (\%)}$$

Calculation example : 28°C=33°C-(33°C-26°C)×71.5%

*The above applies to the case of LGH-100RVX (fan speed 4).

In winter

Air similar to the conditions of the heated (humidified) indoor air is supplied.

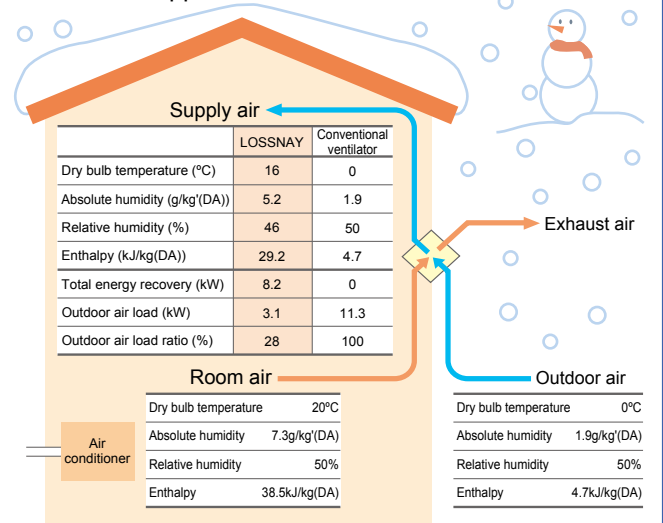

Heat recovery calculation

$$\text{Indoor supply-air temperature (°C)} = \text{Indoor temperature (°C)} - \left(\text{Indoor temperature (°C)} - \text{Outdoor temperature (°C)} \right) \times \text{Temp recovery efficiency (\%)} + \text{Outdoor temperature (°C)}$$

Calculation example : 16°C=(20°C-0°C)×80%+0°C

Product Features

Improved Air Volume Range

Wide range air volume

Unlike the air volume produced by previous models, in which there are the three settings of “High,” “Low,” and “Extra-low,” the new model is equipped with four fan speeds. In addition, each speed has a range setting of 25, 50, 75 and 100%, allowing much finer air volume control.

When used in combination with the CO₂ sensor or timer function, the air volume can be controlled according to conditions that realize better performance and reduce power consumption.

■ Previous model characteristic curves

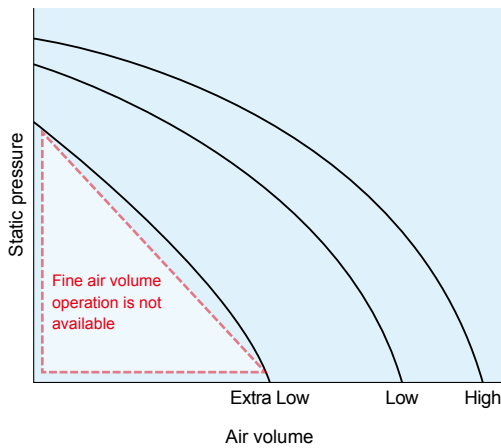

■ New model characteristic curves

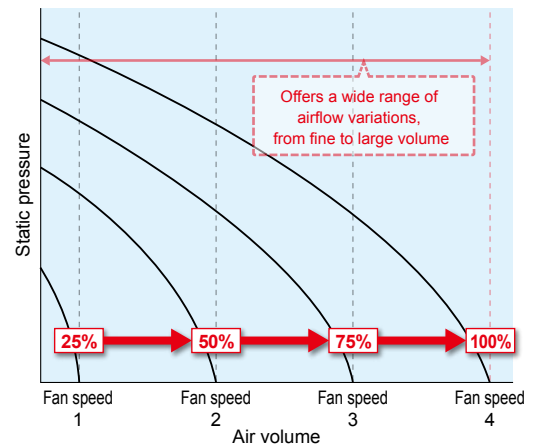

Air volume control by CO₂ sensor

An external CO₂ sensor can be connected directly to the Lossnay RVX units allowing the fan speed to vary according to the CO₂ levels detected. When the CO₂ concentration is low, the unit can operate at a lower air volume compared to previous models and this improves total heat exchange efficiency and contributes to energy saving.

Fan speed 4

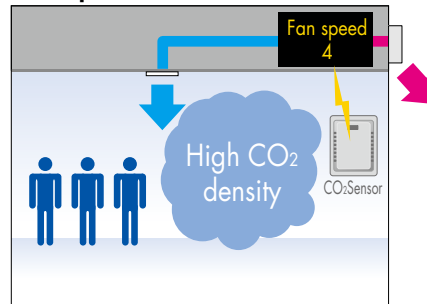

Fan speed 1

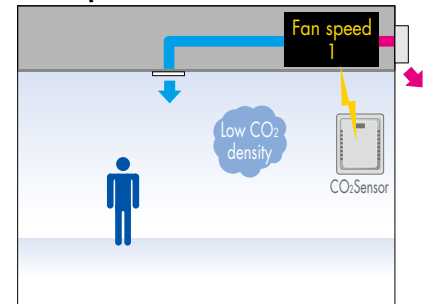

Weekly timer

The operation pattern for each day of the week, ON / OFF and air volume can be set using the weekly timer function (up to eight zones per day). Compared to previous models, much finer operation control contributes to enhanced energysaving operation. With a wider range of air volumes the Lossnay RVX units enable optimised ventilation not just at different times of the day, but for different days of the week as well, enabling further energy savings.

Previous model

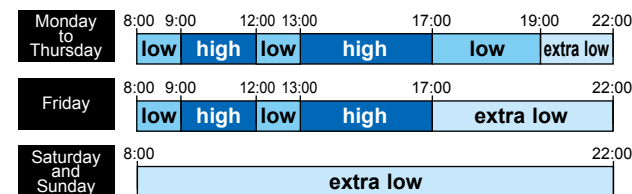

New model

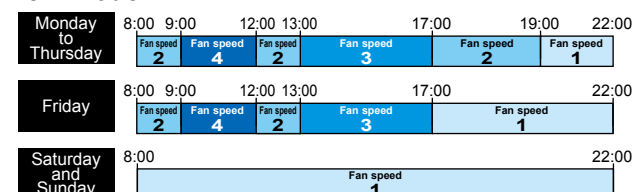

■ Total power consumption in a week

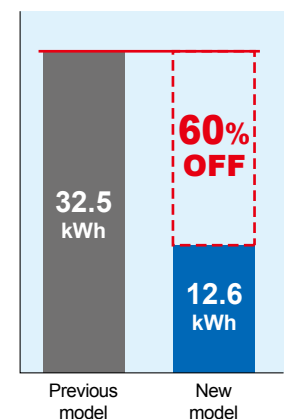

* Comparison of LGH-100RX-E (240V/50Hz) and LGH-100RVX-E (230V/50Hz)

Low noise design

By providing a range of air volume for each fan speed, sound levels can be reduced to achieve low noise.

■ Noise comparison between new and previous models (new model: Fan speed 3, previous model: High)

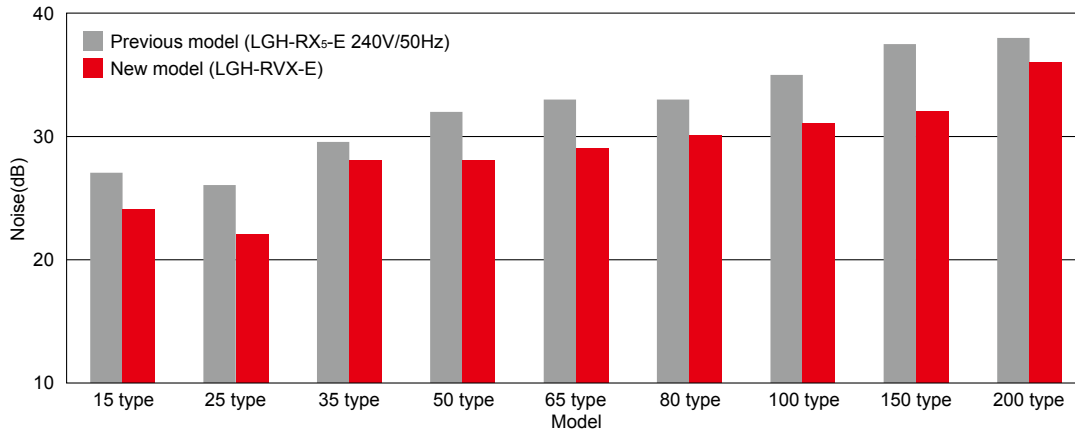

Improved external static pressure

External static pressure has been improved compared to previous models.

By increasing the external static pressure, highly flexible duct work becomes possible thus renewal from existing equipment is easy.

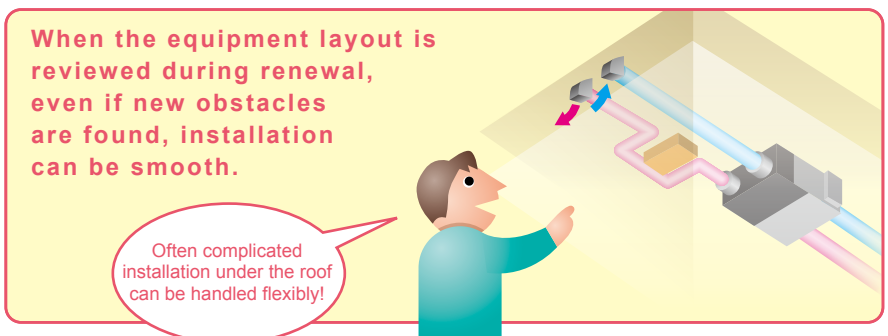

Fan speed adjustment function

The default fan speed value can be adjusted slightly. Use the PZ-61DR-E remote controller to reset the speed.

- 1) Considering the total hours of Lossnay operation (filter clogging), the fan power can be adjusted automatically after a given period of time.
- 2) After the unit is installed, when if the air volume is slightly lower than the desired airflow, it is possible to make fine adjustments.

■ P-Q curve image

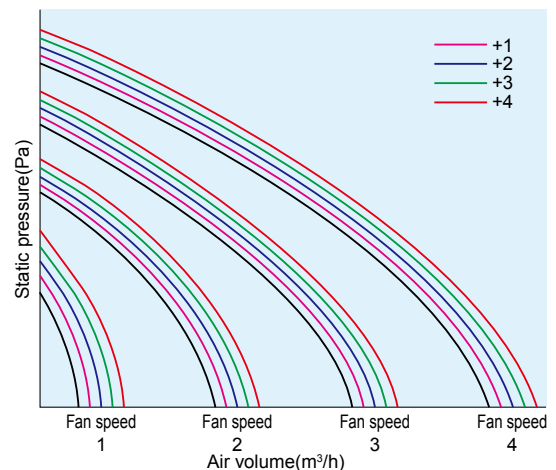

Further Energy Saving Features

Power consumption reduced further with introduction of DC motor

A high efficiency DC motor has been adopted. Compared to models with an AC motor, power consumption is reduced.

■ Comparison between new and previous power consumption (New model: Fan speed 4, Previous model: Extra-High)

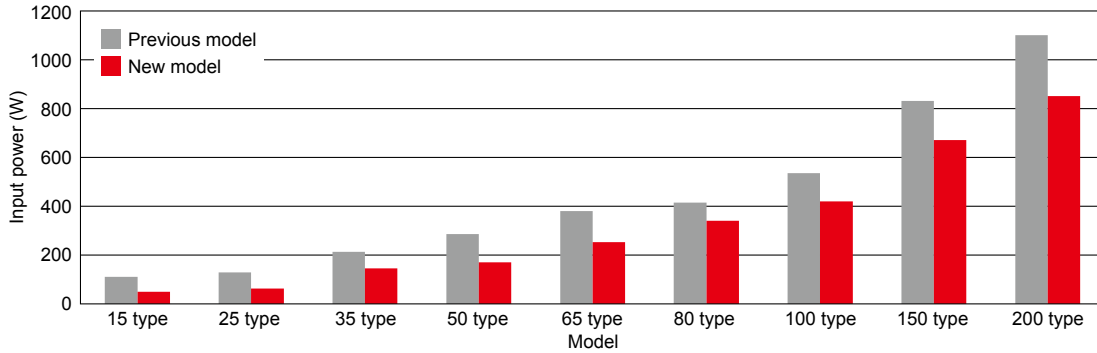

Flexibility in setting Night purge and Auto ventilation mode has improved [PZ-61DR-E]

Night purge

During the summer season, the Night Purge mode draws cooler outside air into the room at night. This energy conservation mode reduces the load when the air conditioning is started up the next morning.

With previous models, the unit is operated with only one condition that is set initially. With new models, it is possible to freely set* the night purge operation for the start conditions, air volume, and operation time and flexibly answer to the operating environment requests that vary with each customer.

* Settings can only be made using the PZ-61DR-E

Previous model

Night purge function operation time

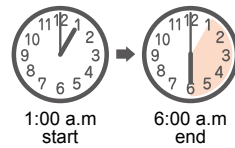

Start condition

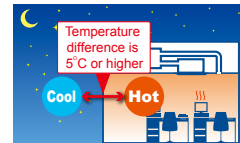

Fan speed

Start the operation at the same fan speed before stopping



New model

Operating time

Possible to set to any time

Start condition (inside-outside temperature difference)

Can be set to between 0°C and 7°C (1°C increments)

Fan speed

Select from Fan speed 1 to 4

Ventilation mode switching

With operation from PZ-61DR-E, it is possible to select manual switching or automatic switching between "Lossnay ventilation (with heat exchange)" and "Bypass ventilation (without heat exchange)".

What is Lossnay ventilation?

Room air is discharged outside via Lossnay core. Heat exchanged outside air is supplied to the room. In summer and winter, air conditioning energy can be recouped by Lossnay unit.

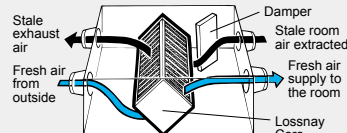

What is bypass ventilation?

Stale room air is discharged to outside without passing through the Lossnay core. In spring and fall when air conditioning is not necessary, the unit operates in bypass ventilation mode.

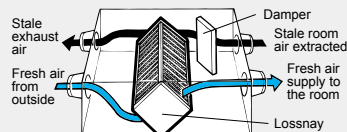

■ By-pass / Lossnay ventilation map in automatic ventilation mode

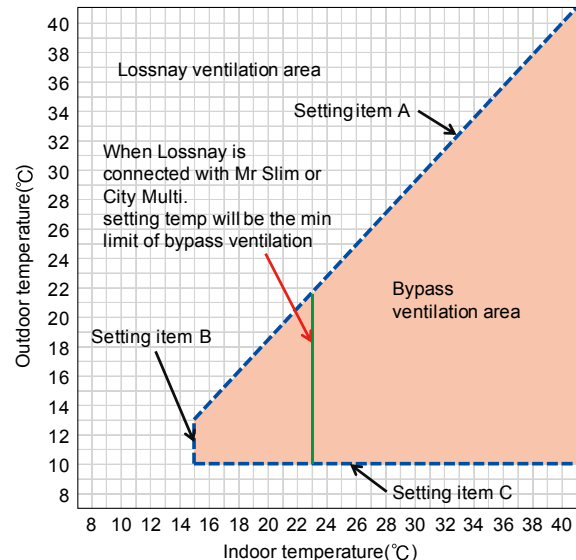

With the previous model, the auto ventilation mode is based on the initial setting condition; however, with the new model it becomes possible to set three setting points, as shown in the table on the right.

* Settings can only be made using the PZ-61DR-E

Optimised System Integration

New remote-control design

The new remote controller improves installation appearance. Full-dot backlit LCD makes it easy to see and control the unit.

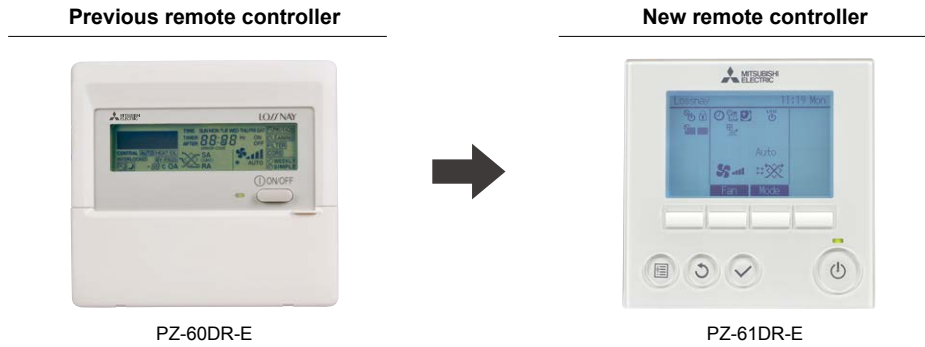

Improved air volume setting flexibility when simultaneously operating with air conditioner

For the specified high and low air volume of the air conditioner, two types of air volumes can be selected, respectively, providing more flexible setting options.

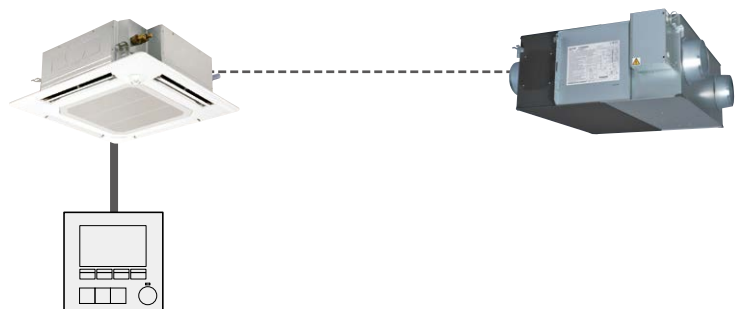

		Previous model	New model
Mr.Slim City Multi	Low	Low	Fan speed 1 or 2*
	High	High or Extra-High	Fan speed 3 or 4*

*factory setting

Improved control with a BMS system

Using a 0-10V signal from the building management system, the air volume of the Lossnay unit can be changed.

■ Connection example : BMS (Building Management System)

Input voltage [VDC]	Fan speed	Fan speed changing from remote controller
0 - 1.0	—	Available
1.5 - 2.5	1	Not available
3.5 - 4.5	2	Not available
5.5 - 7.0	3	Not available
8.5 - 10.0	4	Not available

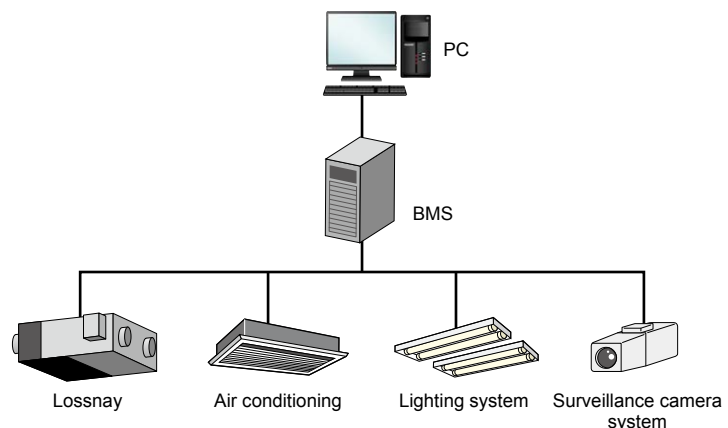

Control

The New Remote Controller PZ-61DR-E enables simple control setting

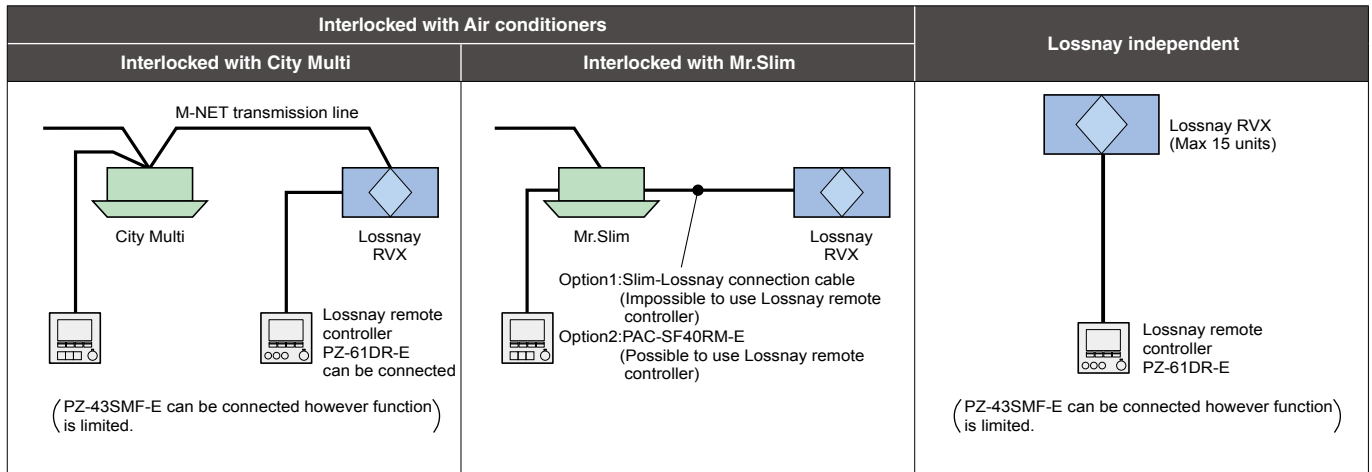

Centralised Controller System

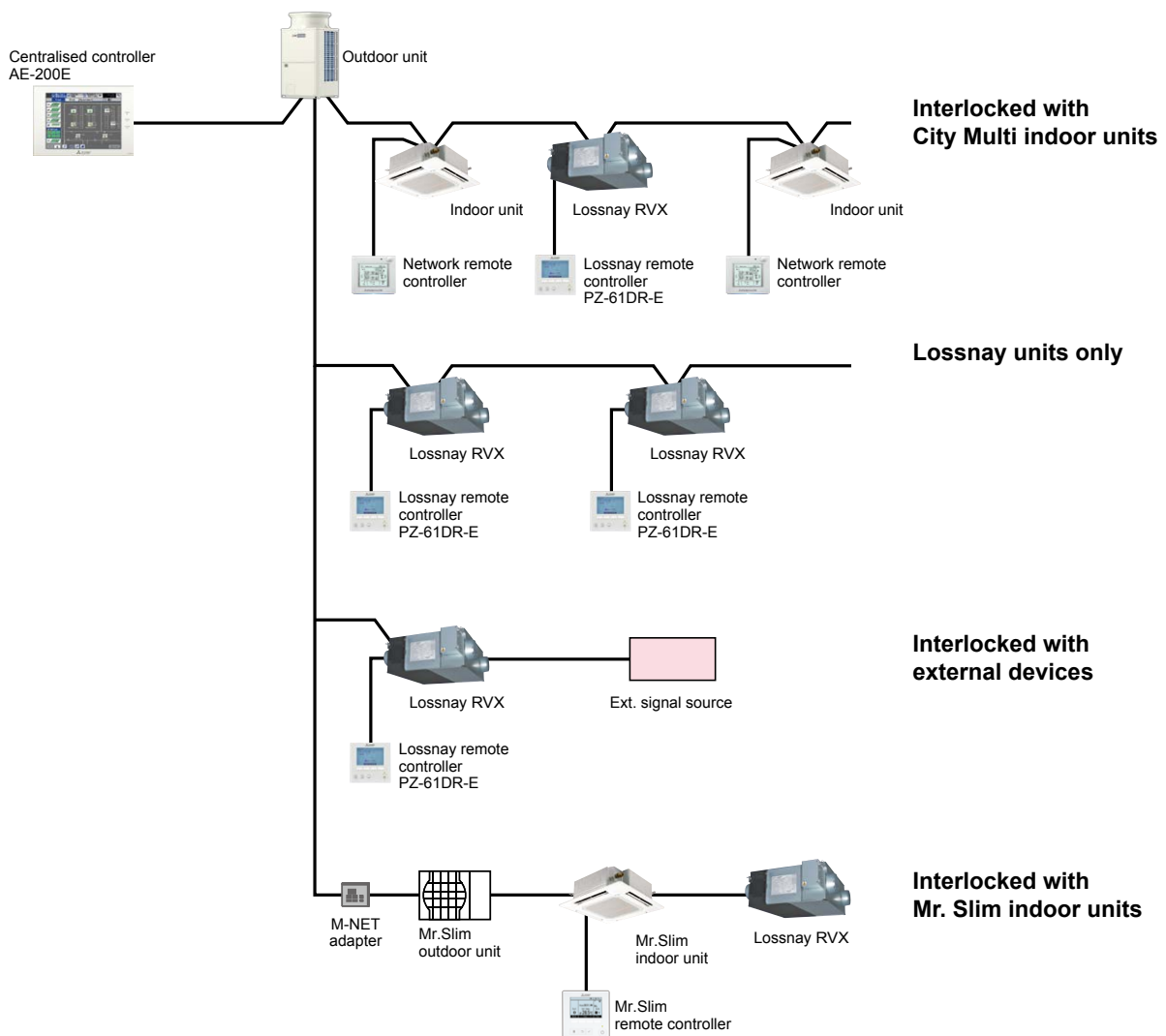

Features of New Centralised Controller "AE-200E"

In an easy and flexible manner, an optimum system can be established according to the scale of facilities.

- Implements control on up to 50 indoor units of air-conditioning equipment.
- By using three units of expansion controller "AE-50E", the centralized control is implemented for the maximum of 200 indoor units.
- Connection with PC allows implementation of control on more than 200 indoor units via Web browser.*1

*1. Please contact your local distributor for when the feature is supported.

System structure

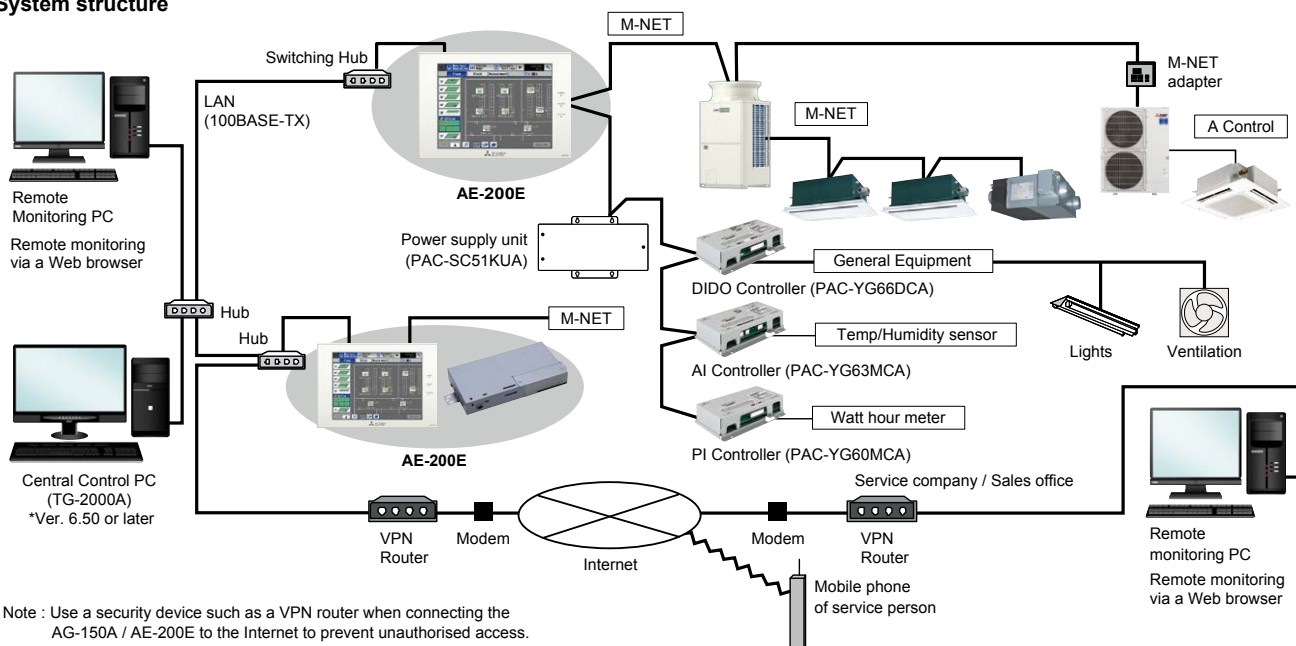

Functions

□ : Each unit ○ : Each group ● : Each block △ : Each floor ◎ : Collective × : Not available

Item	Description	Operations	Display
Controllable number of unit	Up to 50 units/50 groups		
ON/OFF	ON and OFF operation for the air conditioning units and general equipment. (To operate general equipment, PAC-YG66DCA is required.)	○ ○ △ ●	○ ◎
Operation mode	Switches between several operation modes depending on the air conditioning unit. Air conditioning unit : Cool/Dry/Auto(*)/Fan/Heat LOSSNAY unit : Heat Recovery/Bypass/Auto CAHV, CRHV, Air To Water (PWFY) units : Heating, Heating ECO, Hot Water, Anti-freeze, Cooling(**) * Auto mode is for CITY MULTI R2 and WR2 series only. ** Only PWFY	○ ○ △ ●	○
Temperature setting	Cool/Dry : 19°C (67°F) -35°C (95°F) [14°C (57°F) -30°C (87°F)] Heat : 4.5°C (40°F) -28°C (83°F) [17°C (63°F) -28°C (83°F)] Auto : 19°C (67°F) -28°C (83°F) [17°C (63°F) -28°C (83°F)] The range of temperature depends on the air conditioning unit. [] in case of using middle-temperature on PDFY, PEFY-VML/VMR/VMS/VMH-by setting DipSW7-1 to ON. Yet, PEFY-P-VMH-E-F is excluded.	○ ○ △ ●	○
Fan speed setting	Models with 4 air flow speed settings : Hi/Mid-2/Mid-1/Low Models with 3 air flow speed settings : Hi/Mid/Low Models with 2 air flow speed settings : Hi/Low Fan speed setting (including Auto) varies depending on the model.	○ ○ △ ●	○
Air flow direction setting	Air flow direction angles, 4-angles or 5-angles Swing, Auto (Louver cannot be set)	○ ○ △ ●	○
Schedule operation	Weekly schedule can be set by groups based on daily operation pattern.	○ ○ △ ●	○
Permit/prohibit local operation	Individually prohibits operation of each local remote controller function. (ON/OFF, Operation mode, Set temperature, Filter sign reset, Air Direction*, Fan Speed*, Timer*) * This function depends on the model.	○ ○ △ ●	○
Indoor unit intake temperature	Measures the intake temperature of the indoor unit only when the indoor unit is operating.	×	○
Error	When an error is currently occurring on an air conditioning unit, the afflicted unit and the error code are displayed.	×	□ ◎
Test run	This operates air conditioning units in test run mode.	○ ○ △ ●	○
Ventilation interlock	The ventilation unit (LOSSNAY) is able to automatically start its operation when operation of the interlocked indoor unit starts.	○ ○ △ ●	○
External input/output	By using optional external input/output adapter (PAC-YG10HA-E) you can set and monitor the following. Input : By level signal : "Batch ON/OFF"; "Batch emergency stop" By pulse signal : "Batch ON/OFF"; "Enable/disable local remote controller" Output : "ON/OFF"; "Error/Normal"	◎	◎
Energy Management	Bar Graph : Indoor unit Electric Energy, FAN operation time, Thermo-ON time (TOTAL, Cooling, Heating) can be displayed hourly, daily and monthly. Line Graph : Outdoor temp., Room temp., Set temp. (Heating, Cooling) input from PAC-YG63MCA and temp. from AHC.	×	□ ○ ●
Advanced HVAC Controller (AHC)	The status of AHC can only be monitored.	×	○
New Smart ME controller	The status of sensor on this controller can be monitored.	×	○
Smartphone/Tablet	The specified Web browser on iOS and Android OS can monitor and operate AE-200E. *2	○	○
New Web design	The web screen design is renewed for user friendly interface. *2	○ ○ △ ●	○
Initial setting software	The initial setting can be configured without the connection of AE-200E. *2	×	×
Apportionment of power consumption	Apportionment of power consumption can be calculated on AE-200 without TG-2000A. *2	●	□ ●
BACnet® communication	ANSI/ASHRAE 135-2010 (ISO16484-5) is supported and approved by the BTL. *2	○	×

*2 Please contact your local distributor for when the feature is supported.



List of Remote Controller Settings and Functions

The remote controller provides a wide range of functions and features other than the main functions described below, such as sophisticated energy saving control and an easy to see, easy to use interface.

Function (Communicating mode)	PZ-61DR-E	PZ-43SMF-E
Fan speed selection	4 fan speeds	2 of 4 fan speeds
Ventilation mode selection	Energy recovery / Bypass / Auto	Energy recovery / Bypass / Auto
Night-purge (time)	Any time selectable	No
Night-purge (fan speed)	Selectable from 4 fan speeds	No
Dip-switch setting and function setting from RC	Yes	No
Bypass temp. free setting	Yes	No
Heater-On temp. free setting	Yes	No
Fan power up after installation	Yes	No
0 - 10VDC external input	Yes	Yes
ON/OFF timer	Yes	Yes
Auto-Off timer	Yes	No
Weekly timer	Yes	No
Operation restrictions (ON/OFF, Ventilation mode, fan speed)	Yes	No
Operation restrictions (Fan speed skip setting)	Yes	No
Screen contrast adjustment	Yes	No
Language selection	Yes (8 languages)	No (English only)
Initializing remote controller	Yes	No
Filter cleaning sign	Yes	Yes
Lossnay core cleaning sign	Yes	No
Error indication	Yes	Yes
Error history	Yes	No
OA/RA/SA temp. display	Yes	No

Connect ducts in two different directions (OA, EA side)

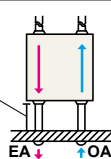
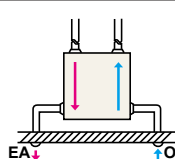
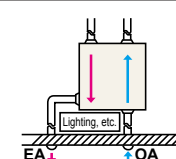
Ducts can be connected in two different directions to the outdoor vents thanks to collars and aperture plates that can be interchangeably placed in two different positions. This flexibility allows for installations close to the surface of a wall and helps avoid cases where the stale air exhaust vent would be blocked by an obstruction of some kind. This makes both planning and installation that much simpler.

Standard installation	Installation with duct direction changed	
<p>A space is necessary to prevent the influx of rainwater.</p> 	<p>Can be installed close to the surface of the wall.</p> 	<p>Avoid installations where the stale air exhaust aperture would be blocked by lighting or air conditioning units.</p> 
 <p>Flange Plate</p>	<p>Changing the duct direction</p>  <p>Exchangeable</p> <p>Remove the flange (factory-standard direction) and the side panel plate and switch their placements. They are both equipped with screw stoppers making the switch extremely simple. The direction of the ducts can only be changed on the outside (OA and EA). The inside cannot be changed (SA and RA).</p>	

OA/EA square duct (LGH-150 / 200R)

OA/EA is square duct. This simplifies installation and reduces total installation time.

Controllers

LOSSNAY remote controller (PZ-61DR-E)

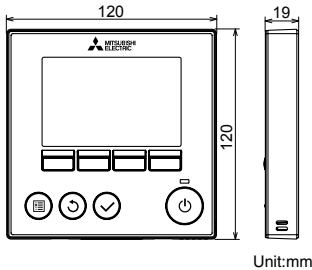

Operation section

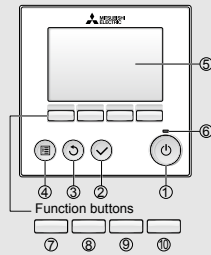

- ① Press to turn ON/OFF the Lossnay unit.
- ② Press to save the setting.
- ③ Press to return to the previous screen.
- ④ Press to bring up the Main menu.
- ⑤ Operation settings will appear.
When the backlight is off, pressing any button turns the backlight on and it will stay lit for a certain period of time depending on the screen.
- ⑥ This lamp lights up in green while the unit is in operation. It blinks while the remote controller is starting up or when there is an error.
- ⑦ Main menu : Press to move the cursor down.
- ⑧ Main display : Press to change the fan speed.
- ⑨ Main display : Press to change the ventilation mode.
- ⑩ Main menu : Press to go to the next page.

Display section

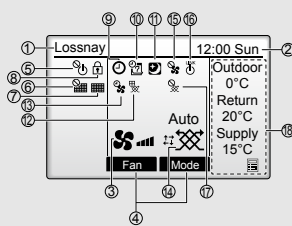

- ① Lossnay is always displayed.
- ② Current time appears here
- ③ Fan speed setting appears here.
- ④ Functions of the corresponding buttons appear here.
- ⑤ Appears when the ON/OFF operation is centrally controlled.
- ⑥ Appears when the filter reset function is centrally controlled.
- ⑦ Indicates when filter and/or Lossnay core needs maintenance.
- ⑧ Appears when the buttons are locked and/or a fan speed is skipped.
- ⑨ Appears when the On/Off timer, or Auto-off timer function is enabled.
- ⑩ Appears when the Weekly timer is enabled.
- ⑪ Appears when the night-purge function is available.
- ⑫ Appears when performing operation to protect the equipment.
- ⑬ Appears when performing the power supply/exhaust function or the delay operation at the start of operation.
- ⑭ Indicates the ventilation mode setting.
- ⑮ Appears when external fan speed operation.
- ⑯ Appears when operation interlocked with external unit.
- ⑰ Appears when external ventilation mode operation.
- ⑱ Displays the outdoor temperature, return temperature, and supply temperature (calculated value).

LOSSNAY remote controller (PZ-43SMF-E)

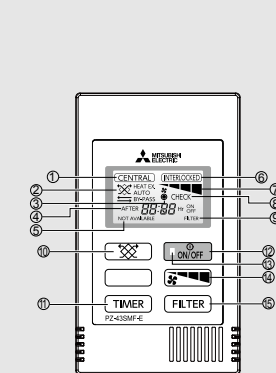
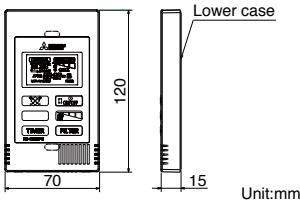

- ① Displayed during remote operation prohibited by central control unit, etc.
- ② Displays the ventilation mode status.
Heat exchange HEAT EX.
By-pass BY-PASS
Automatic (HEAT EX./BY-PASS) HEAT EX. or AUTO BY-PASS
- ③ Displayed while the Lossnay remote controller is powered on.
- ④ Displays on-timer or off-timer duration.
- ⑤ When a button is pressed for a function which the Lossnay unit cannot perform, this display flashes concurrently with the display of the function.
- ⑥ Displayed when the Lossnay starts off by interlocked indoor unit or external signal.
- ⑦ Displays the selected fan speed.
- ⑧ Displayed together with the malfunctioning unit (3 digits) and an error code (4 digits).
- ⑨ Displayed when the accumulated operating time reaches the time set for filter maintenance.
- ⑩ Used to select the ventilation mode among heat exchange, by-pass or automatic.
- ⑪ Increasing 0:30 by pressing it once. Keep pressing the button for fast-forwarding.
- ⑫ Switch for start and stop.
- ⑬ On during operation. Flashes when a malfunction occurs.
- ⑭ Used to select the fan speed either "Low" or "High".
Low High
- ⑮ Press twice to reset the filter sign display.

Filters

Standard filter

Replacement components for the standard air filter supplied with the LOSSNAY LGH main unit.

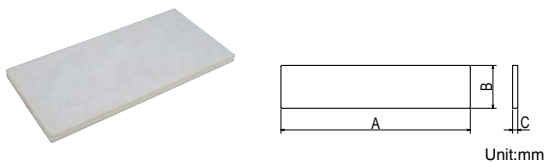

High-efficiency filter

This high-efficiency filter can be incorporated inside the LOSSNAY unit without the need to attach parts from other systems, as done to date. The main unit external dimensions are unchanged, and the air volume ranges between 150m³/h and 2,000m³/h.

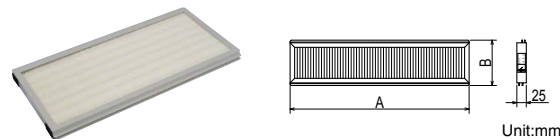

Incorporation into the main unit is simple, and filter changes can be performed via the main unit inspection opening.

Model	Dimension (mm)			Number of filters per set		Applicable model	Filter material
	A	B	C	Supply	Exhaust		
PZ-15RF _E -E	557	130	20	1	1	LGH-15RVX-E	Nonwoven filter Filtration efficiency (EU-G3)
PZ-25RF _E -E	333	156	15	2	2	LGH-25RVX-E	
PZ-35RF _E -E	399	183	20	2	2	LGH-35RVX-E	
PZ-50RF _E -E	470	183	15	2	2	LGH-50RVX-E	
PZ-65RF _E -E	433	218	15	2	2	LGH-65RVX-E	
PZ-80RF _E -E	451	243	15	2	2	LGH-80RVX-E, LGH-150RVX-E(2sets)	
PZ-100RF _E -E	565	243	15	2	2	LGH-100RVX-E, LGH-200RVX-E(2sets)	

Model	Dimension (mm)		Number of filters per set	Applicable model	Filter material
	A	B			
PZ-15RFM-E	553	123	1	LGH-15RVX-E	Noncombustible fiber (polyester-polyolefin) (M6 EN779:2012)
PZ-25RFM-E	327	148	2	LGH-25RVX-E	
PZ-35RFM-E	393	175	2	LGH-35RVX-E	
PZ-50RFM-E	464	175	2	LGH-50RVX-E	
PZ-65RFM-E	427	209	2	LGH-65RVX-E	
PZ-80RFM-E	446	236	2	LGH-80RVX-E, LGH-150RVX-E(2sets)	
PZ-100RFM-E	559	236	2	LGH-100RVX-E, LGH-200RVX-E(2sets)	

Job Reference

School



The reason for choosing Lossnay

The school needed to meet strict criteria for energy conservation and efficiency and the school does just that, but this means that it's almost airtight which can lead to problems with the build-up of stale air

To meet the demand fundamental to the comfort of those using the building is the use of Mitsubishi Electric's Lossnay fresh air, mechanical heat recovery ventilation and Ecodan® CAHV air source heat pump boilers to provide the school's hot water and heating. Mr Slim air conditioning units are used to deliver efficient heating and cooling.

The merits of use

The installation of 18 units of LGH-100R Lossnay mechanical heat recovery ventilation units. The units keep the classrooms full of fresh air, whilst extracting up to 80% of the heating from the outgoing air and transferring it to heat up the incoming air flow.

Mitsubishi Electric HVAC features

Mitsubishi Electric's advanced air conditioning is one of the best at delivering energy efficient cooling to where it's needed most. And with the Lossnay fresh air ventilation units and Ecodan® CAHV heating system.

Installation Summary

Application : Primary school

Product : 18 x LGH-100R Lossnay mechanical heat recovery ventilation units

Results : The units keep the classrooms full of fresh air, whilst extracting up to 80% of the heating from the outgoing air and transferring it to heat up the incoming air flow

Office



The reason for choosing Lossnay

When it came to selecting a fresh air ventilation system for its new Head Office the company was well placed to select the best.

Lossnay is an effective ventilation system that works alongside the City Multi Variable Refrigerant Flow (VRF) air conditioning that has also been installed, to provide employees with the optimum environment in which to work comfortably and safely.

The merits of use

The Lossnay technology reduces overall energy costs by extracting stale air from a room and recovering the heating or cooling energy from it ; this energy is then used to warm or cool incoming fresh air. Using recovered energy means that the system can save up to 30% on the initial capital costs of a heating and cooling plant.

Lossnay's features

The LGH Lossnay series offers a free cooling function and when the outdoor temperature is lower than the indoor air conditioned temperature , Lossnay will provide cool, fresh outdoor air to reduce the indoor air temperature therefore reducing the energy requirement and running costs.

Installation Summary

Application : Office

Product : Lossnay LGH-200R and LGH-50R units provide mechanical heat recover ventilation

Results : The system recovers around 80% of wasted heat from the outgoing exhaust air
Lossnay can work independently or alongside existing heating and cooling systems
The units also offer a free summer cooling function

Specifications / Dimensions

LGH-15 to 100RVX-E

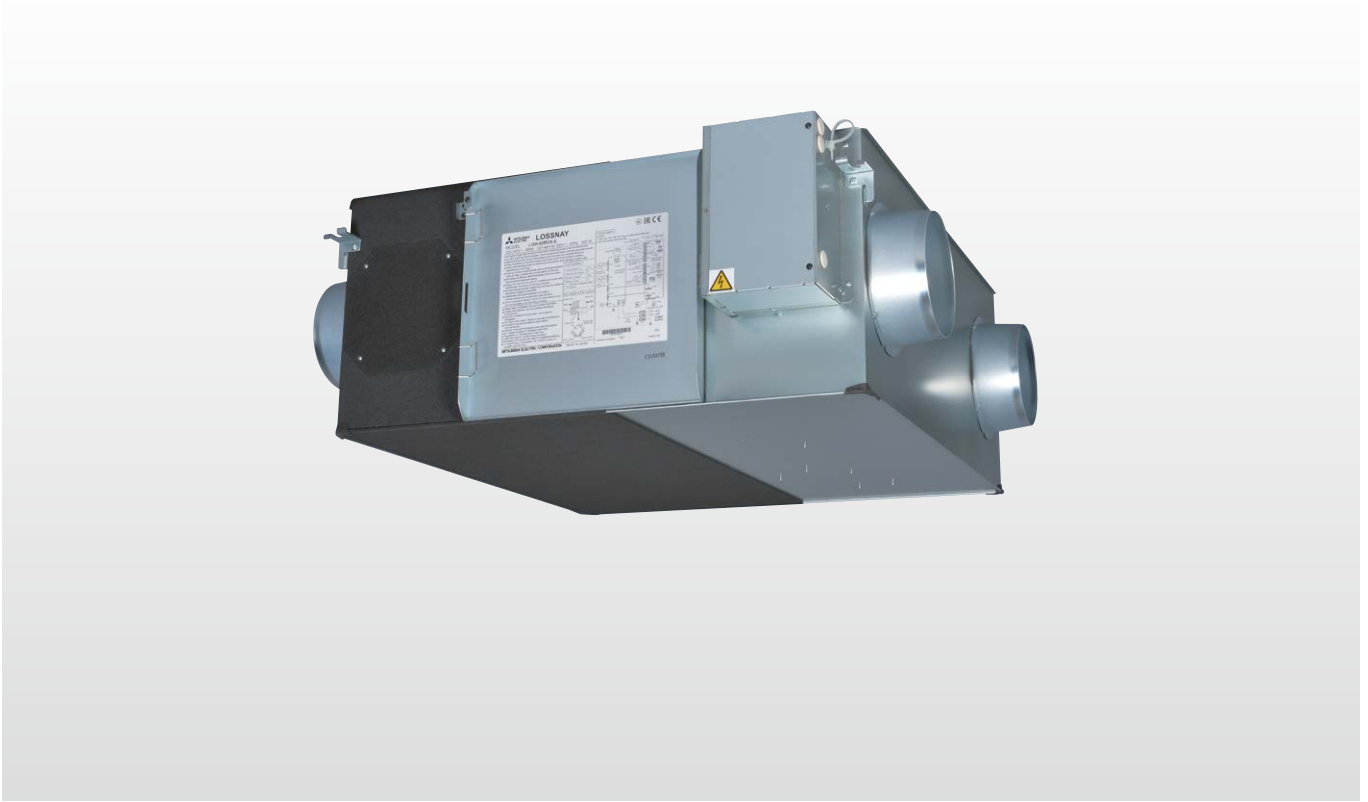

LGH-150 and 200RVX-E

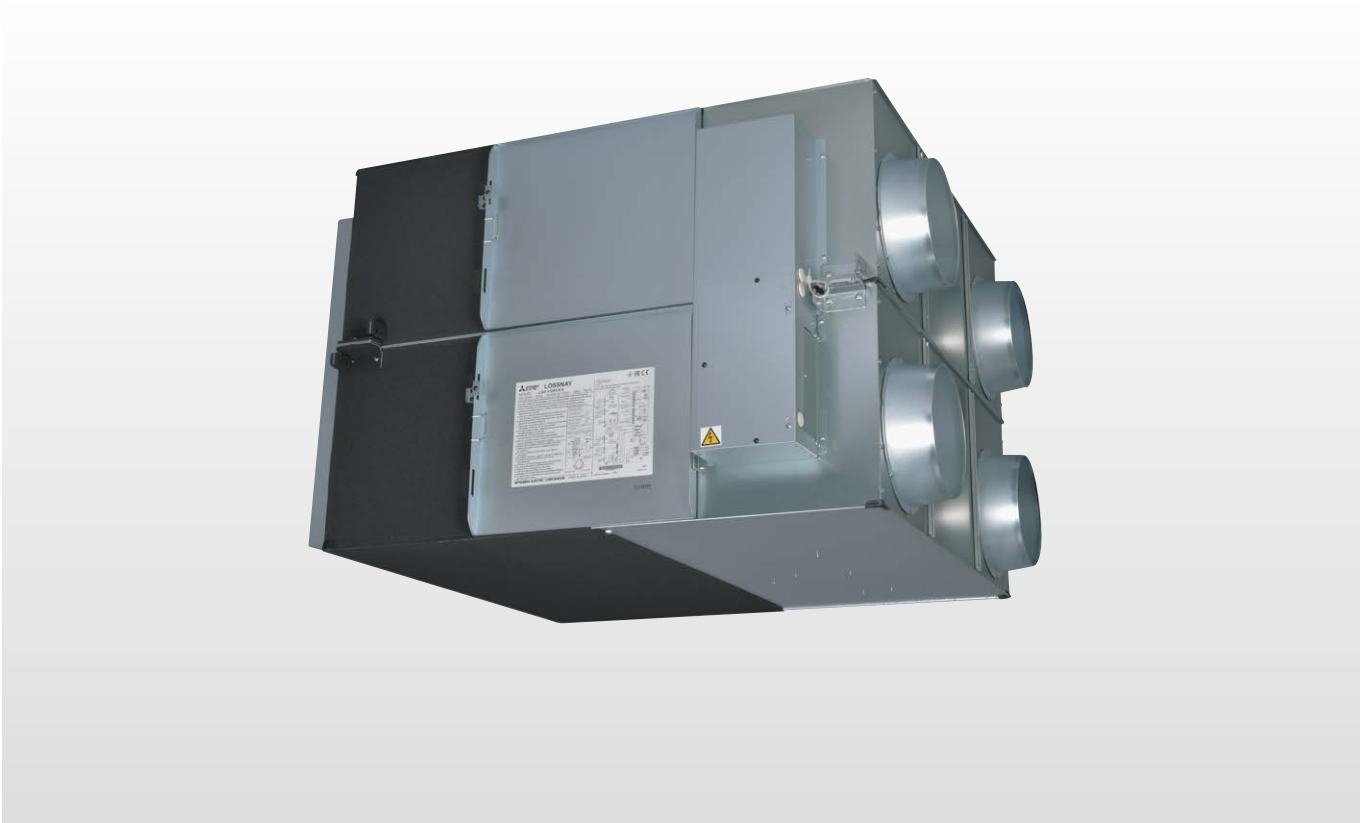

Model		LGH-15RVX-E								
Electrical power supply		220-240V/50Hz, 220V/60Hz								
Ventilation mode		Heat recovery mode				Bypass mode				
Fan speed		SP4	SP3	SP2	SP1	SP4	SP3	SP2	SP1	
Running current (A)		0.40	0.24	0.15	0.10	0.41	0.25	0.15	0.10	
Input power (W)		49	28	14	7	52	28	14	8	
Air volume		(m³/h)	150	113	75	38	150	113	75	38
		(L/s)	42	31	21	10	42	31	21	10
External static pressure (Pa)		95	54	24	6	95	54	24	6	
Temperature exchange efficiency (%)		Heating	80.0	81.0	83.0	84.0	—	—	—	—
		Cooling	72.0	75.0	80.0	84.0	—	—	—	—
Enthalpy exchange efficiency (%)		Heating	73.0	75.5	78.0	79.0	—	—	—	—
		Cooling	71.0	74.5	78.0	79.0	—	—	—	—
Noise (dB) (Measured at 1.5m under the center of unit in an anechoic chamber)		28.0	24.0	19.0	17.0	29.0	24.0	19.0	18.0	
Weight (kg)		20								
Specific energy consumption class		A								

*The Air outlets noise (45° angle, 1.5 meters in front of the unit) is about 13dB greater than the indicated value. (at Fan speed 4)

*The running current, the input power, the efficiency and the noise are based on the rating air volume, and 230V 50Hz / 220V 60Hz

*For the specification at the other frequency contact your dealer.

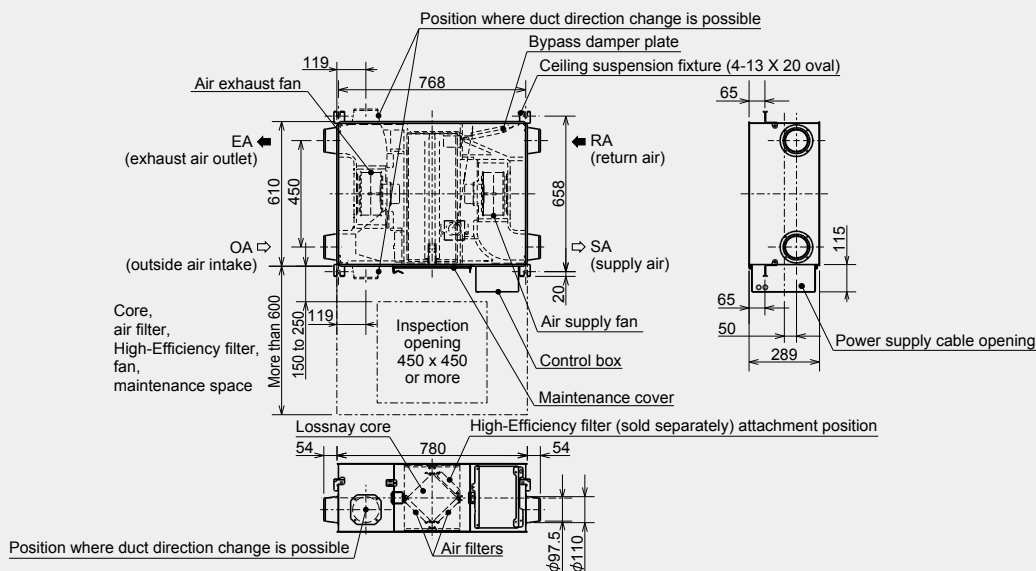
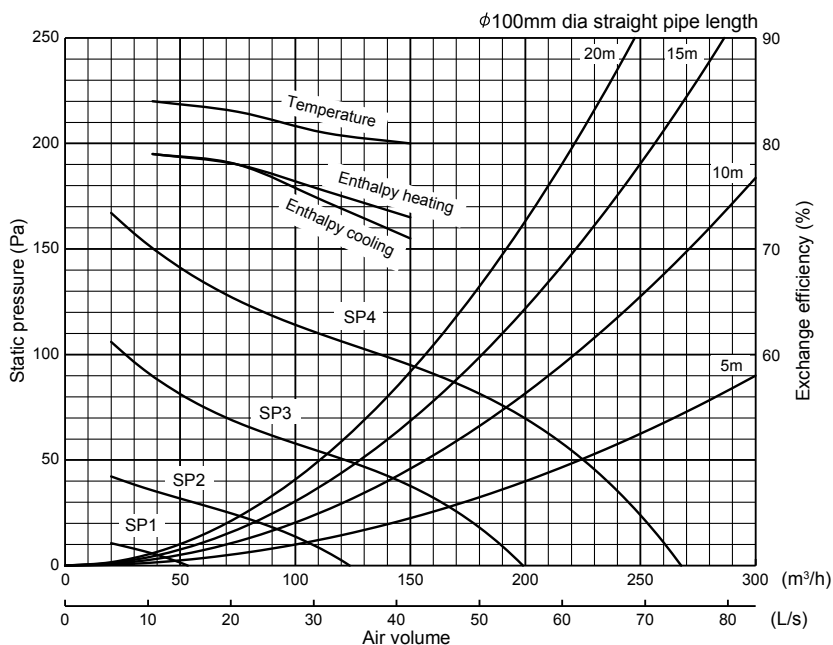

Unit: mm

Model		LGH-25RVX-E								
Electrical power supply		220-240V/50Hz, 220V/60Hz								
Ventilation mode		Heat recovery mode				Bypass mode				
Fan speed		SP4	SP3	SP2	SP1	SP4	SP3	SP2	SP1	
Running current (A)		0.48	0.28	0.16	0.10	0.48	0.29	0.16	0.11	
Input power (W)		62	33	16	7.5	63	35	17	9	
Air volume		(m³/h)	250	188	125	63	250	188	125	63
		(L/s)	69	52	35	17	69	52	35	17
External static pressure (Pa)		85	48	21	5	85	48	21	5	
Temperature exchange efficiency (%)		Heating	79.0	80.0	82.0	86.0	—	—	—	—
		Cooling	73.0	78.5	82.0	86.0	—	—	—	—
Enthalpy exchange efficiency (%)		Heating	69.5	72.0	76.0	83.0	—	—	—	—
		Cooling	68.0	70.0	74.5	83.0	—	—	—	—
Noise (dB) (Measured at 1.5m under the center of unit in an anechoic chamber)		27.0	22.0	20.0	17.0	27.5	23.0	20.0	17.0	
Weight (kg)		23								
Specific energy consumption class		A								

*The Air outlets noise (45° angle, 1.5 meters in front of the unit) is about 15dB greater than the indicated value. (at Fan speed 4)

*The running current, the input power, the efficiency and the noise are based on the rating air volume, and 230V 50Hz / 220V 60Hz

*For the specification at the other frequency contact your dealer.

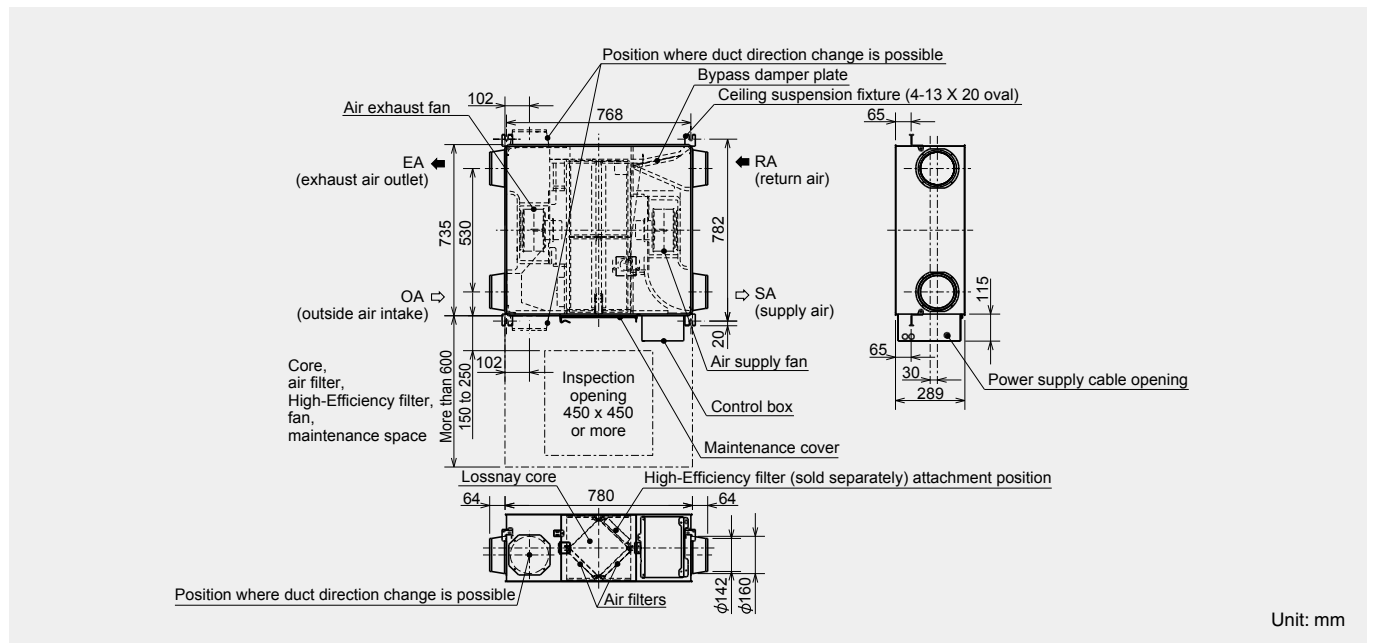
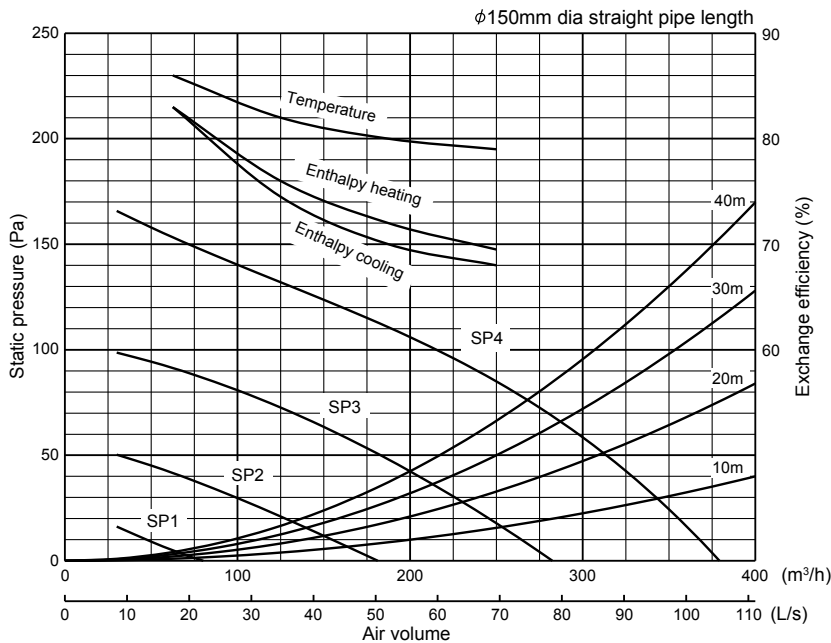

Unit: mm

Model		LGH-35RVX-E								
Electrical power supply		220-240V/50Hz, 220V/60Hz								
Ventilation mode		Heat recovery mode				Bypass mode				
Fan speed		SP4	SP3	SP2	SP1	SP4	SP3	SP2	SP1	
Running current (A)		0.98	0.54	0.26	0.12	0.98	0.56	0.28	0.13	
Input power (W)		140	70	31	11	145	72	35	13	
Air volume		(m ³ /h)	350	263	175	88	350	263	175	88
		(L/s)	97	73	49	24	97	73	49	24
External static pressure (Pa)		160	90	40	10	160	90	40	10	
Temperature exchange efficiency (%)		Heating	80.0	82.5	86.0	88.5	—	—	—	—
		Cooling	72.5	78.0	84.5	87.0	—	—	—	—
Enthalpy exchange efficiency (%)		Heating	71.5	74.0	78.5	83.5	—	—	—	—
		Cooling	71.0	73.0	78.0	82.0	—	—	—	—
Noise (dB) (Measured at 1.5m under the center of unit in an anechoic chamber)		32.0	28.0	20.0	17.0	32.5	28.0	20.0	18.0	
Weight (kg)		30								

*The Air outlets noise (45° angle, 1.5 meters in front of the unit) is about 12dB greater than the indicated value. (at Fan speed 4)

*The running current, the input power, the efficiency and the noise are based on the rating air volume, and 230V 50Hz / 220V 60Hz

*For the specification at the other frequency contact your dealer.

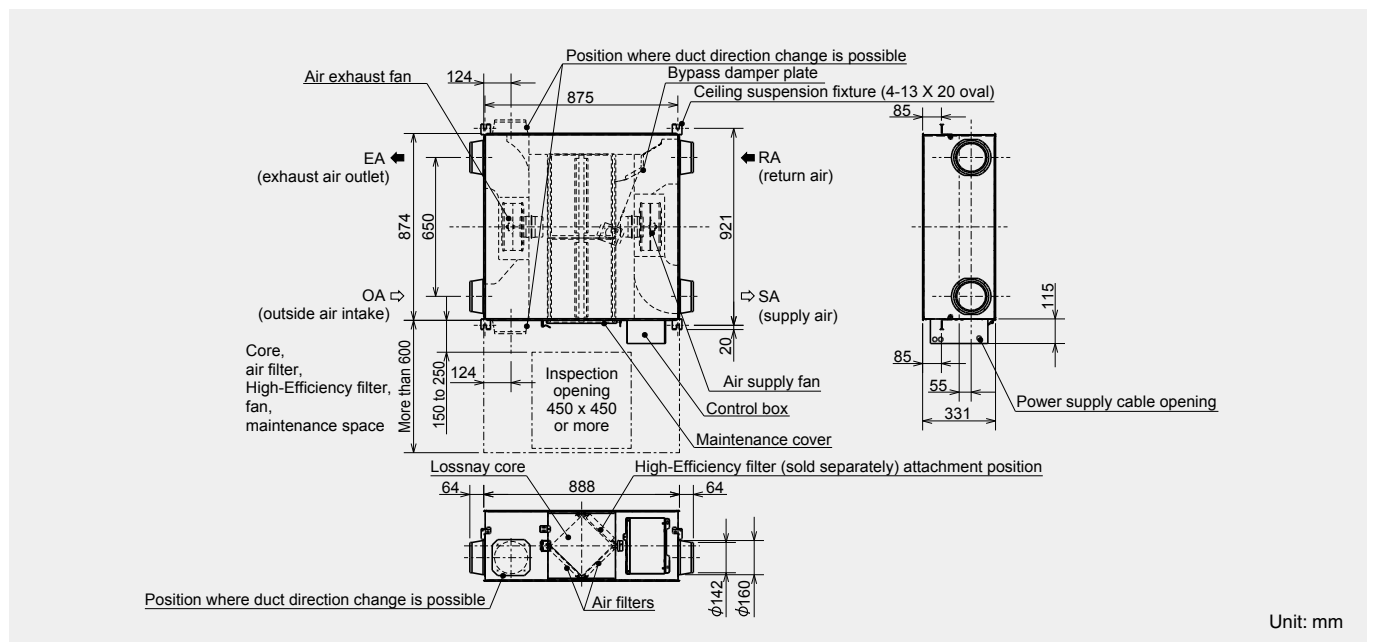
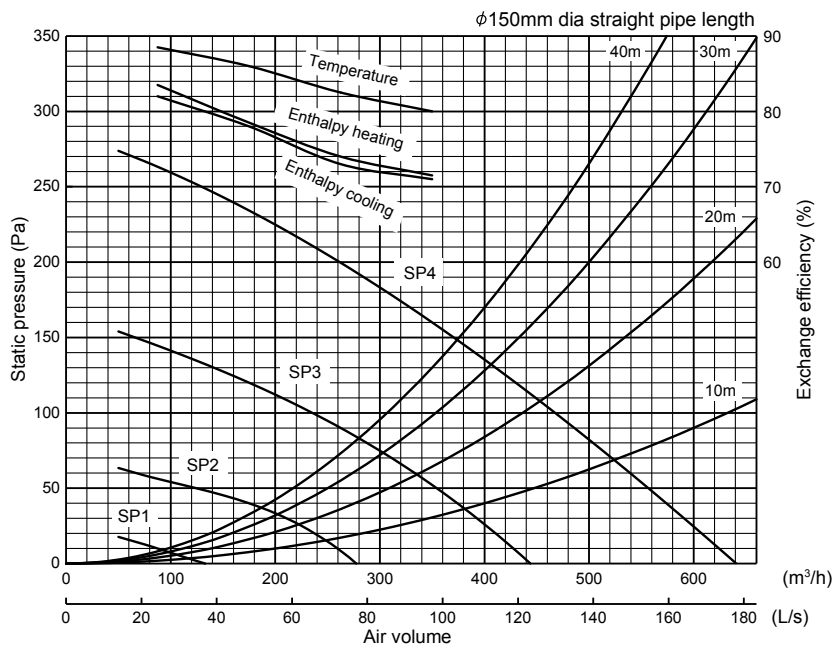

Unit: mm

Model		LGH-50RVX-E								
Electrical power supply		220-240V/50Hz, 220V/60Hz								
Ventilation mode		Heat recovery mode				Bypass mode				
Fan speed		SP4	SP3	SP2	SP1	SP4	SP3	SP2	SP1	
Running current (A)		1.15	0.59	0.26	0.13	1.15	0.59	0.27	0.13	
Input power (W)		165	78	32	12	173	81	35	14	
Air volume		(m³/h)	500	375	250	125	500	375	250	125
		(L/s)	139	104	69	35	139	104	69	35
External static pressure (Pa)		120	68	30	8	120	68	30	8	
Temperature exchange efficiency (%)		Heating	78.0	81.0	83.5	87.0	—	—	—	—
		Cooling	70.5	75.5	79.0	87.0	—	—	—	—
Enthalpy exchange efficiency (%)		Heating	69.0	71.0	75.0	82.5	—	—	—	—
		Cooling	66.5	68.0	72.5	82.0	—	—	—	—
Noise (dB) (Measured at 1.5m under the center of unit in an anechoic chamber)		34.0	28.0	19.0	18.0	35.0	29.0	20.0	18.0	
Weight (kg)		33								

*The Air outlets noise (45° angle, 1.5 meters in front of the unit) is about 18dB greater than the indicated value. (at Fan speed 4)
 *The running current, the input power, the efficiency and the noise are based on the rating air volume, and 230V 50Hz / 220V 60Hz
 *For the specification at the other frequency contact your dealer.

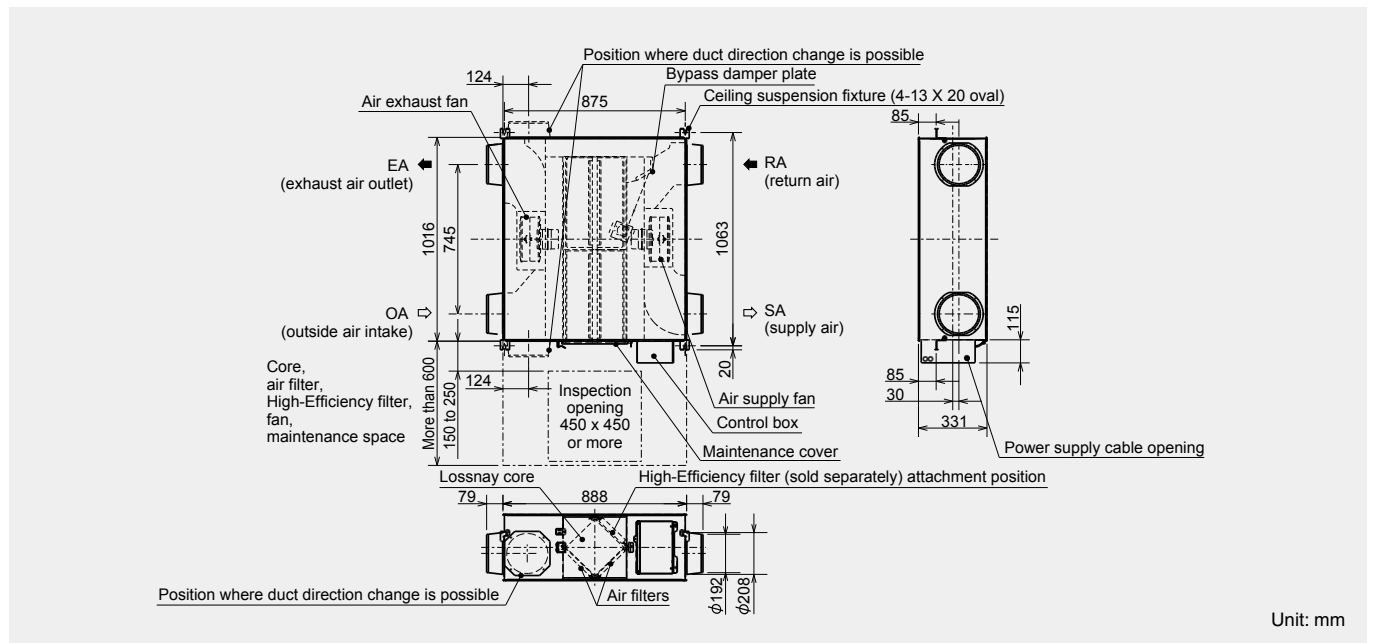
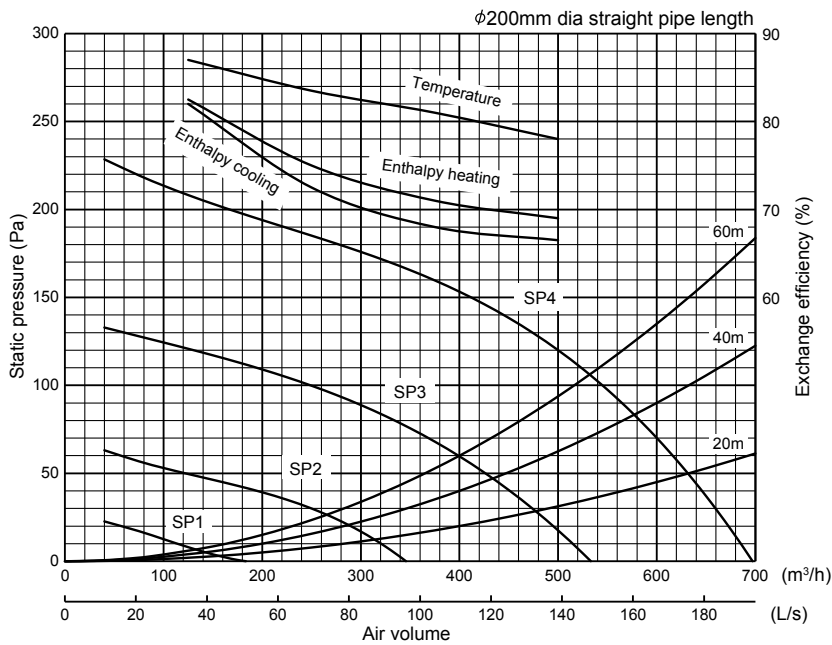

Unit: mm

Model		LGH-65RVX-E								
Electrical power supply		220-240V/50Hz, 220V/60Hz								
Ventilation mode		Heat recovery mode				Bypass mode				
Fan speed		SP4	SP3	SP2	SP1	SP4	SP3	SP2	SP1	
Running current (A)		1.65	0.90	0.39	0.15	1.72	0.86	0.38	0.16	
Input power (W)		252	131	49	15	262	131	47	17	
Air volume		(m³/h)	650	488	325	163	650	488	325	163
		(L/s)	181	135	90	45	181	135	90	45
External static pressure (Pa)		120	68	30	8	120	68	30	8	
Temperature exchange efficiency (%)		Heating	77.0	81.0	84.0	86.0	—	—	—	—
		Cooling	69.0	73.5	80.5	86.0	—	—	—	—
Enthalpy exchange efficiency (%)		Heating	68.5	71.0	76.0	82.0	—	—	—	—
		Cooling	66.0	69.5	74.0	81.0	—	—	—	—
Noise (dB) (Measured at 1.5m under the center of unit in an anechoic chamber)		34.5	29.0	22.0	18.0	35.5	29.0	22.0	18.0	
Weight (kg)		38								

*The Air outlets noise (45° angle, 1.5 meters in front of the unit) is about 16dB greater than the indicated value. (at Fan speed 4)

*The running current, the input power, the efficiency and the noise are based on the rating air volume, and 230V 50Hz / 220V 60Hz

*For the specification at the other frequency contact your dealer.

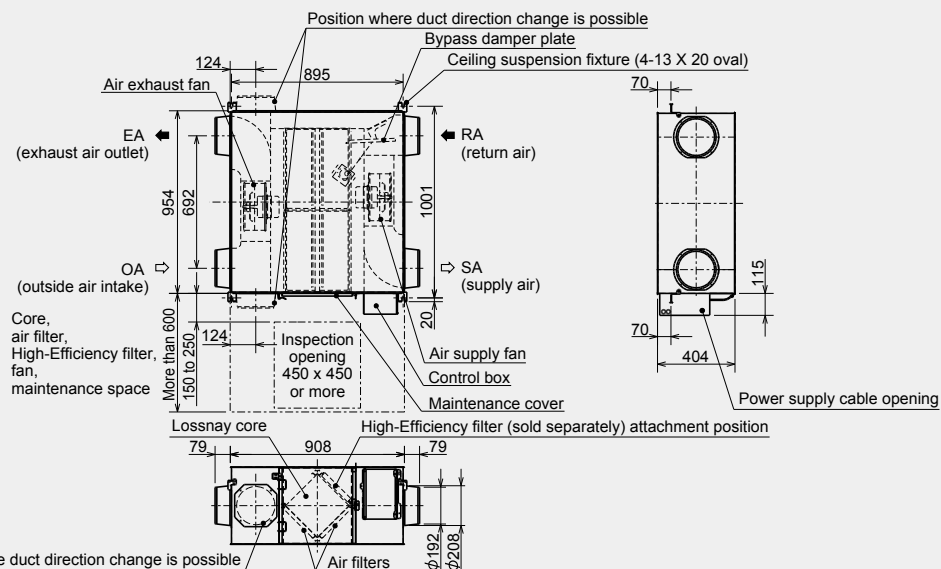
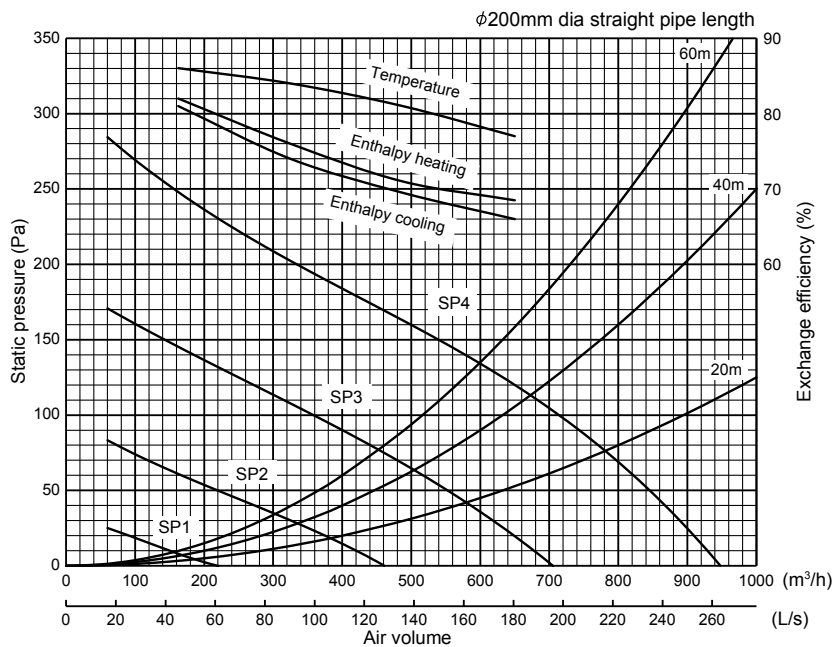

Unit: mm

Model		LGH-80RVX-E								
Electrical power supply		220-240V/50Hz, 220V/60Hz								
Ventilation mode		Heat recovery mode				Bypass mode				
Fan speed		SP4	SP3	SP2	SP1	SP4	SP3	SP2	SP1	
Running current (A)		1.82	0.83	0.36	0.15	1.97	0.86	0.40	0.15	
Input power (W)		335	151	60	18	340	151	64	20	
Air volume		(m ³ /h)	800	600	400	200	800	600	400	200
		(L/s)	222	167	111	56	222	167	111	56
External static pressure (Pa)		150	85	38	10	150	85	38	10	
Temperature exchange efficiency (%)		Heating	79.0	82.5	84.0	85.0	—	—	—	—
		Cooling	71.5	78.0	83.0	85.0	—	—	—	—
Enthalpy exchange efficiency (%)		Heating	71.0	73.5	78.0	81.0	—	—	—	—
		Cooling	70.0	72.5	78.0	81.0	—	—	—	—
Noise (dB) (Measured at 1.5m under the center of unit in an anechoic chamber)		34.5	30.0	23.0	18.0	36.0	30.0	23.0	18.0	
Weight (kg)		48								

*The Air outlets noise (45° angle, 1.5 meters in front of the unit) is about 24dB greater than the indicated value. (at Fan speed 4)
 *The running current, the input power, the efficiency and the noise are based on the rating air volume, and 230V 50Hz / 220V 60Hz
 *For the specification at the other frequency contact your dealer.
 *Use this unit with static pressure 240Pa or less at Fan speed4. Otherwise the noise level might be larger.

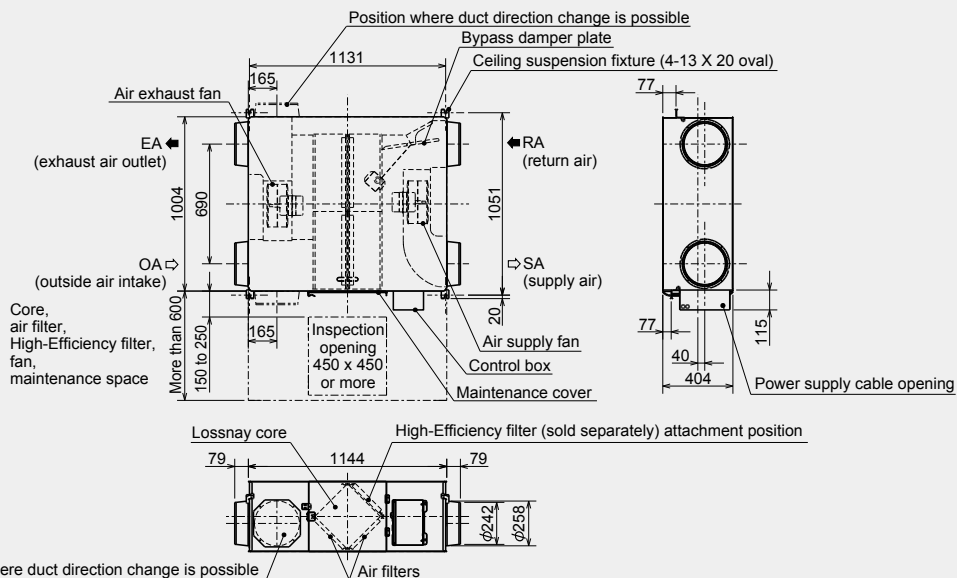
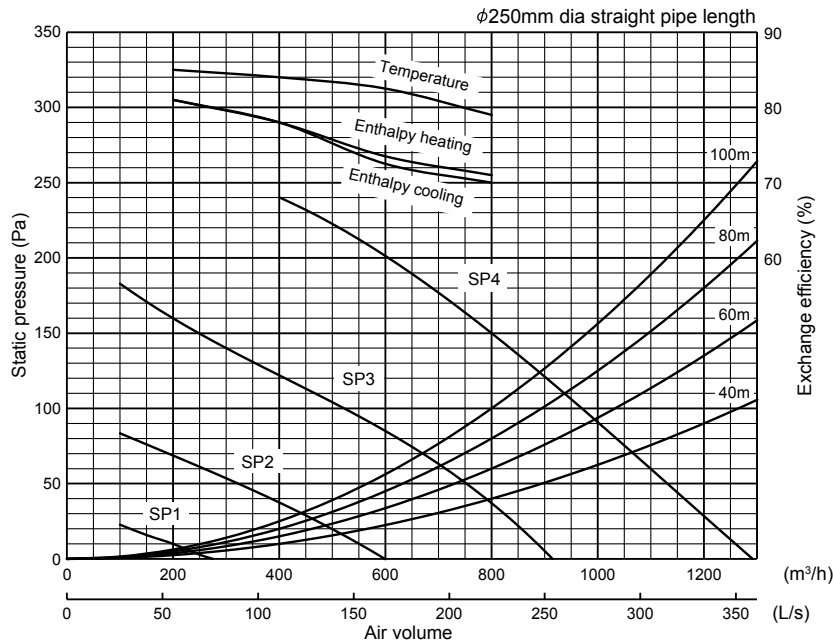

Unit: mm

Model		LGH-100RVX-E								
Electrical power supply		220-240V/50Hz, 220V/60Hz								
Ventilation mode		Heat recovery mode				Bypass mode				
Fan speed		SP4	SP3	SP2	SP1	SP4	SP3	SP2	SP1	
Running current (A)		2.50	1.20	0.50	0.17	2.50	1.20	0.51	0.19	
Input power (W)		420	200	75	21	420	200	75	23	
Air volume		(m ³ /h)	1000	750	500	250	1000	750	500	250
		(L/s)	278	208	139	69	278	208	139	69
External static pressure (Pa)		170	96	43	11	170	96	43	11	
Temperature exchange efficiency (%)		Heating	80.0	83.0	86.5	89.5	—	—	—	—
		Cooling	71.5	78.0	85.0	89.5	—	—	—	—
Enthalpy exchange efficiency (%)		Heating	72.5	74.0	78.0	87.0	—	—	—	—
		Cooling	71.0	73.0	77.0	85.5	—	—	—	—
Noise (dB) (Measured at 1.5m under the center of unit in an anechoic chamber)		37.0	31.0	23.0	18.0	38.0	32.0	24.0	18.0	
Weight (kg)		54								

*The Air outlets noise (45° angle, 1.5 meters in front of the unit) is about 21dB greater than the indicated value. (at Fan speed 4)

*The running current, the input power, the efficiency and the noise are based on the rating air volume, and 230V 50Hz / 220V 60Hz

*For the specification at the other frequency contact your dealer.

*Use this unit between static pressure 60Pa and 240Pa at Fan speed 4. Otherwise the motor protection may work and reduce its output or the noise level might be larger.

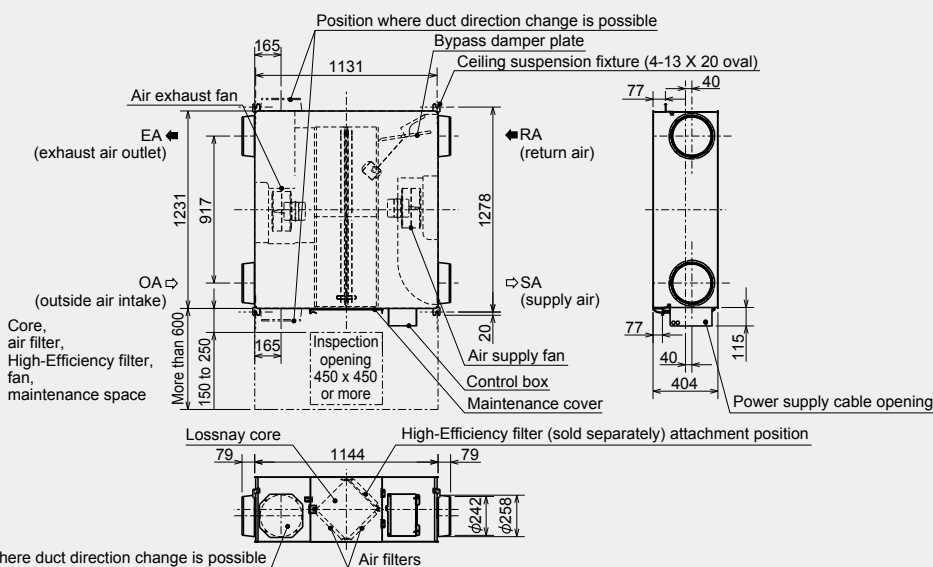
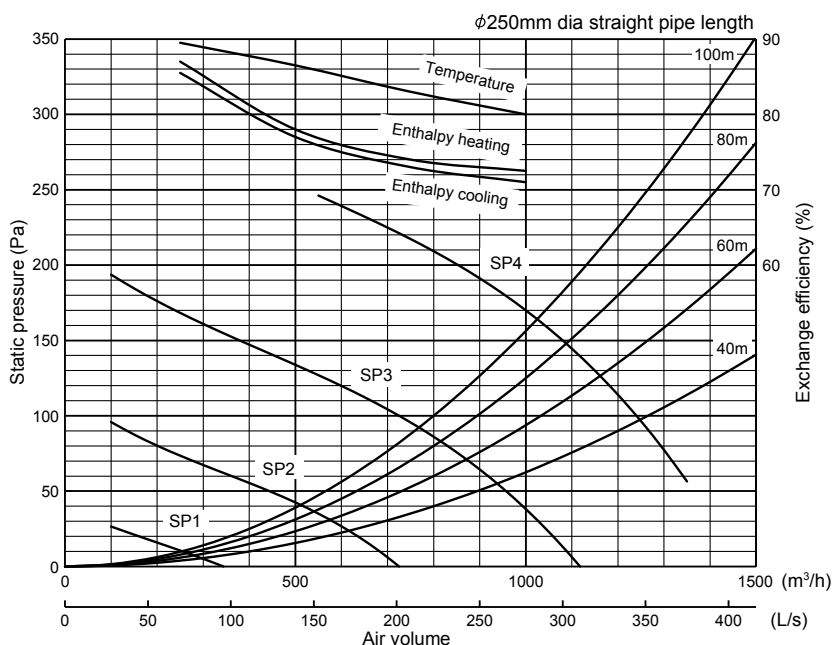

Unit: mm

Model		LGH-150RVX-E								
Electrical power supply		220-240V/50Hz, 220V/60Hz								
Ventilation mode		Heat recovery mode				Bypass mode				
Fan speed		SP4	SP3	SP2	SP1	SP4	SP3	SP2	SP1	
Running current (A)		3.71	1.75	0.70	0.29	3.85	1.78	0.78	0.30	
Input power (W)		670	311	123	38	698	311	124	44	
Air volume		(m³/h)	1500	1125	750	375	1500	1125	750	375
		(L/s)	417	313	208	104	417	313	208	104
External static pressure (Pa)		175	98	44	11	175	98	44	11	
Temperature exchange efficiency (%)		Heating	80.0	82.5	84.0	85.0	—	—	—	—
		Cooling	71.5	78.0	83.0	85.0	—	—	—	—
Enthalpy exchange efficiency (%)		Heating	72.0	73.5	78.0	81.0	—	—	—	—
		Cooling	70.5	72.5	78.0	81.0	—	—	—	—
Noise (dB) (Measured at 1.5m under the center of unit in an anechoic chamber)		39.0	32.0	24.0	18.0	40.5	33.0	26.0	18.0	
Weight (kg)		98								

*The Air outlets noise (45° angle, 1.5 meters in front of the unit) is about 22dB greater than the indicated value. (at Fan speed 4)
 *The running current, the input power, the efficiency and the noise are based on the rating air volume, and 230V 50Hz / 220V 60Hz
 *For the specification at the other frequency contact your dealer.
 *Use this unit with static pressure 250Pa or less at Fan speed4. Otherwise the noise level might be larger.

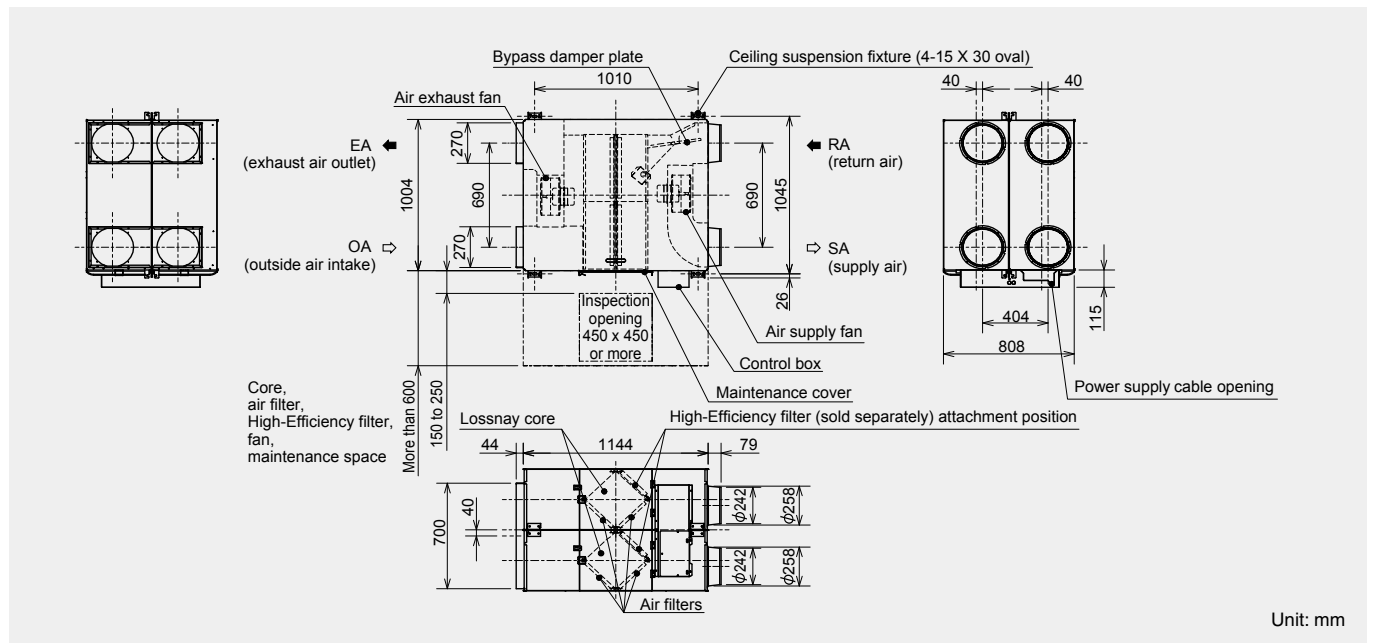
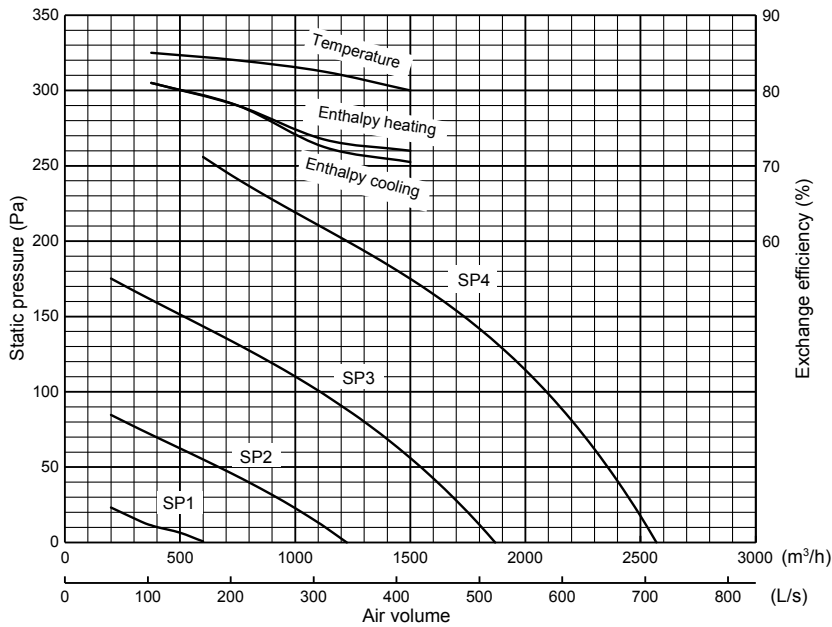

Unit: mm

Model		LGH-200RVX-E								
Electrical power supply		220-240V/50Hz, 220V/60Hz								
Ventilation mode		Heat recovery mode				Bypass mode				
Fan speed		SP4	SP3	SP2	SP1	SP4	SP3	SP2	SP1	
Running current (A)		4.88	2.20	0.88	0.33	4.54	2.06	0.87	0.35	
Input power (W)		850	400	153	42	853	372	150	49	
Air volume		(m³/h)	2000	1500	1000	500	2000	1500	1000	500
		(L/s)	556	417	278	139	556	417	278	139
External static pressure (Pa)		150	84	38	10	150	84	38	10	
Temperature exchange efficiency (%)		Heating	80.0	83.0	86.5	89.5	—	—	—	—
		Cooling	71.5	78.0	85.0	89.5	—	—	—	—
Enthalpy exchange efficiency (%)		Heating	72.5	74.0	78.0	87.0	—	—	—	—
		Cooling	71.0	73.0	77.0	85.5	—	—	—	—
Noise (dB) (Measured at 1.5m under the center of unit in an anechoic chamber)		40.0	36.0	28.0	18.0	41.0	36.0	27.0	19.0	
Weight (kg)		110								

*The Air outlets noise (45° angle, 1.5 meters in front of the unit) is about 21dB greater than the indicated value. (at Fan speed 4)

*The running current, the input power, the efficiency and the noise are based on the rating air volume, and 230V 50Hz / 220V 60Hz

*For the specification at the other frequency contact your dealer.

*Use this unit between static pressure 50Pa and 220Pa at Fan speed4. Otherwise the motor protection may work and reduce its output or the noise level might be larger.

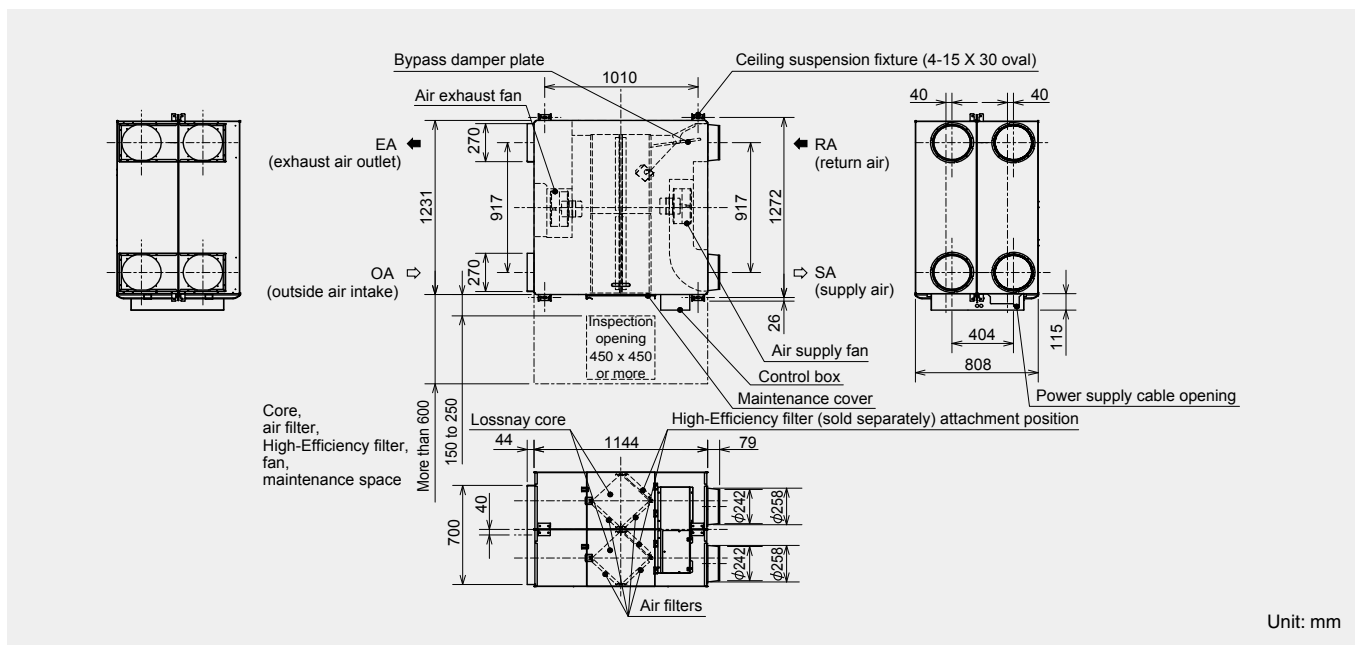
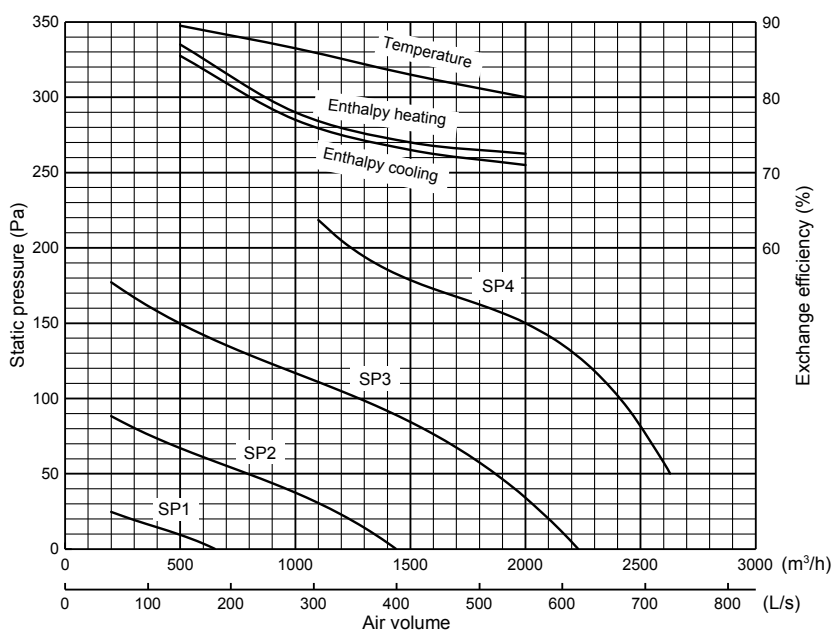

Unit: mm

Wiring Diagrams

LGH-15 to 100RVX-E

- * TM1, TM2, TM3, TM4, TB5 shown in dotted lines are field work.
- * Be sure to connect the ground wire.
- * A power supply isolator must be installed.
- * Always use an isolator for the main switch power connection.

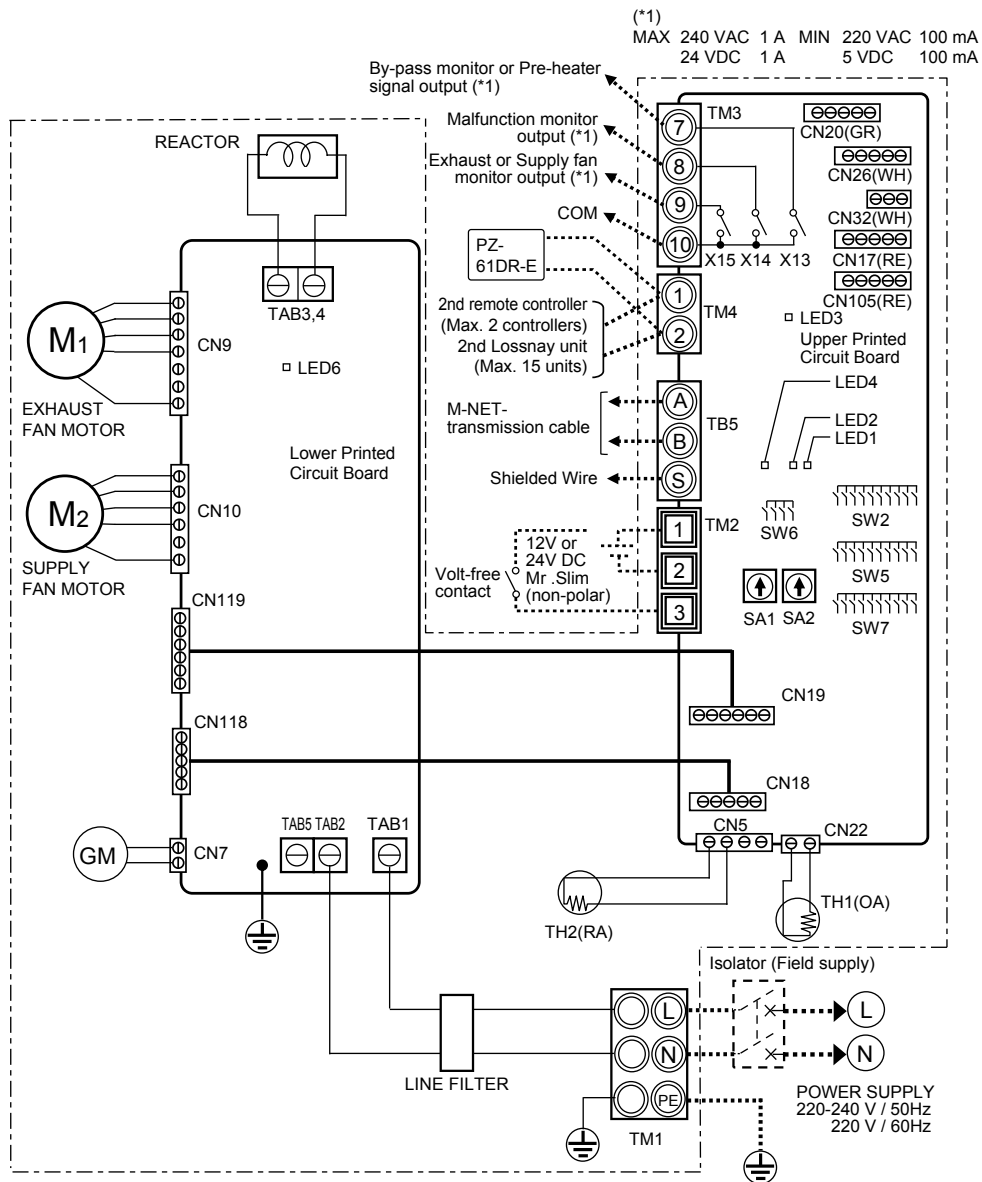

Definition of symbols

M1: Motor for exhaust fan	TAB1, TAB2, (TAB5): Connector (Power supply)	CN19: Connector
M2: Motor for supply fan	TAB3, TAB4: Connector (Reactor)	CN119: Connector
GM: Motor for Bypass damper	X13: Relay contact	CN20: Connector (For communication with the Dx-coil unit)
TH1: Thermistor for outside air	X14: Relay contact	CN22: Connector (Thermistor OA)
TH2: Thermistor for return air	X15: Relay contact	CN26: Connector (Bypass, 0 - 10 V DC Fan speed control)
SW2, 5, 7: Switch (Function selection)	CN5: Connector (Thermistor RA)	CN32: Connector (Remote control selection)
SW6: Switch (Model selection)	CN7: Connector (Motor for Bypass damper)	CN105: Connector (For IT communication)
TM1: Terminal block (Power supply)	CN9: Connector (Fan motor)	SA1: Address setting rotary switch (tens digit)
TM2: Terminal block (External control input)	CN10: Connector (Fan motor)	SA2: Address setting rotary switch (ones digit)
TM3: Terminal block (Monitor output)	CN17: Connector (Fan speed 1/2/3/4)	LED1, LED2: Inspection indicator lamp
TM4: Terminal block (Transmission cable)	CN18: Connector	LED3: Remote controller power supply indicator lamp
TB5: Terminal block (M-NET Transmission cable)	CN118: Connector	LED4, LED6: Power supply indicator lamp
		SYMBOL □ ⊞ : Terminal block, ⊞ : Connector on PCB

Select proper circuit breaker according to the electrical current information in the chart below.

Model	LGH-15RVX-E	LGH-25RVX-E	LGH-35RVX-E	LGH-50RVX-E	LGH-65RVX-E	LGH-80RVX-E	LGH-100RVX-E
Maximum current when operating [A]	0.55	0.72	1.95	2.10	2.50	2.80	3.45
Inrush current after power supply ON [A]	10 ms			6.1			
	100 ms			3.6			

LGH-150 and 200RVX-E

- * TM1, TM2, TM3, TM4, TB5 shown in dotted lines are field work.
- * Be sure to connect the ground wire.
- * A power supply isolator must be installed.
- * Always use an isolator for the main switch power connection.

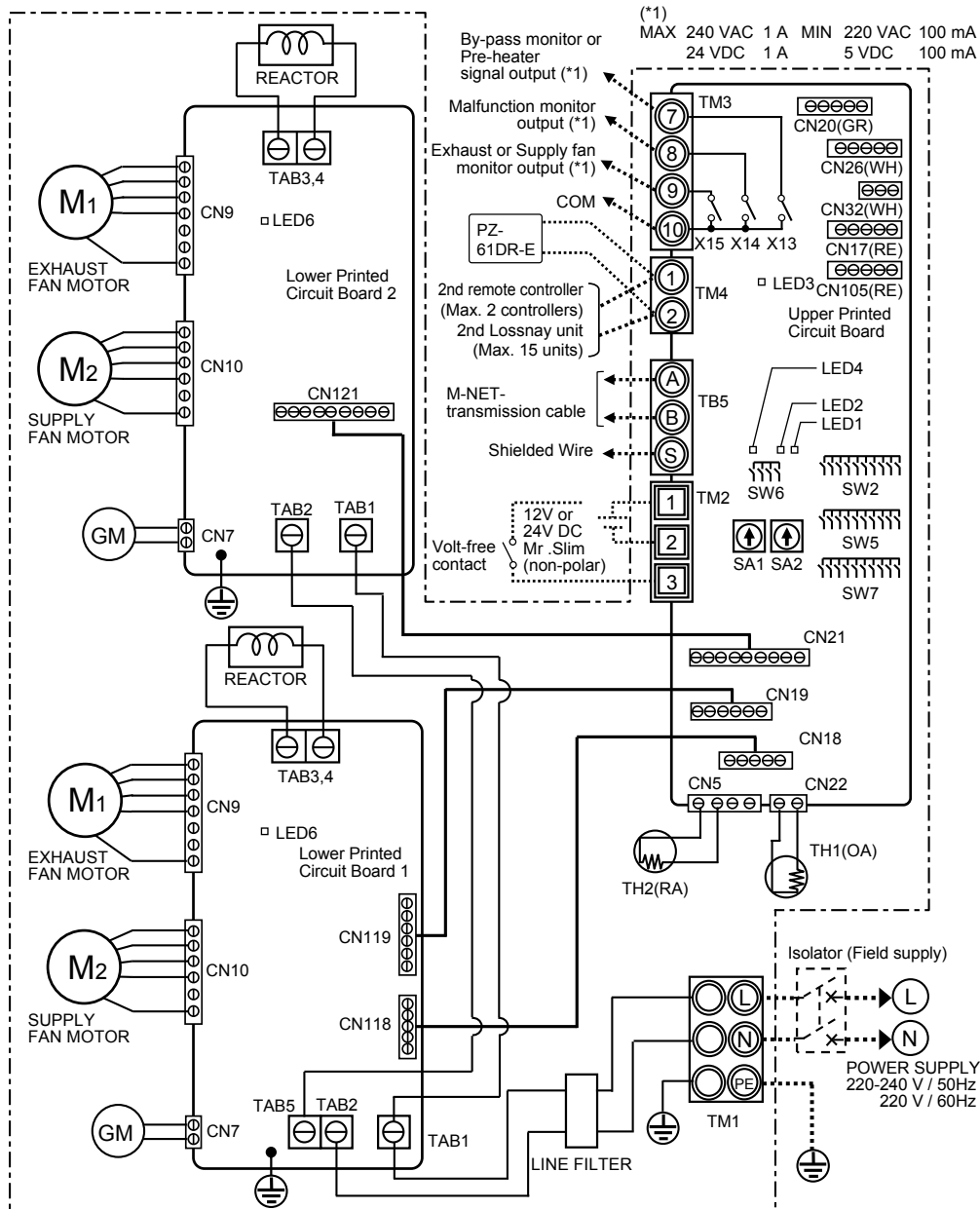

Definition of symbols

M1: Motor for exhaust fan	TAB3, TAB4: Connector (Reactor)	CN20: Connector (For communication with the Dx-coil unit)
M2: Motor for supply fan	X13: Relay contact	CN21: Connector
GM: Motor for Bypass damper	X14: Relay contact	CN121: Connector
TH1: Thermistor for outside air	X15: Relay contact	CN22: Connector (Thermistor OA)
TH2: Thermistor for return air	CN5: Connector (Thermistor RA)	CN26: Connector (Bypass, 0 - 10 V DC Fan speed control)
SW2, 5, 7: Switch (Function selection)	CN7: Connector (Motor for Bypass damper)	CN32: Connector (Remote control selection)
SW6: Switch (Model selection)	CN9: Connector (Fan motor)	CN105: Connector (For IT communication)
TM1: Terminal block (Power supply)	CN10: Connector (Fan motor)	SA1: Address setting rotary switch (tens digit)
TM2: Terminal block (External control input)	CN17: Connector (Fan speed 1/2/3/4)	SA2: Address setting rotary switch (ones digit)
TM3: Terminal block (Monitor output)	CN18: Connector	LED1, LED2: Inspection indicator lamp
TM4: Terminal block (Transmission cable)	CN118: Connector	LED3: Remote controller power supply indicator lamp
TB5: Terminal block (M-NET Transmission cable)	CN19: Connector	LED4, LED6: Power supply indicator lamp
TAB1, TAB2, TAB5: Connector (Power supply)	CN119: Connector	SYMBOL : Terminal block, : Connector on PCB

Select proper circuit breaker according to the electrical current information in the chart below.

Model	LGH-150RVX-E	LGH-200RVX-E
Maximum current when operating [A]	5.76	6.34
Inrush current after power supply ON [A]	10 ms	12.2
	100 ms	7.2

Sample Installations

Standard installation examples

•Duct length

Model	Distance
LGH-15 to 65RVX-E	1 m or more
LGH-80 and 100RVX-E	2.5 m or more
LGH-150 and 200RVX-E	3 m or more

•The parts can also be installed upside down. Remove the maintenance cover, rotate the parts by 180°, and re-install.

* It can be installed by inverting the top and the bottom.

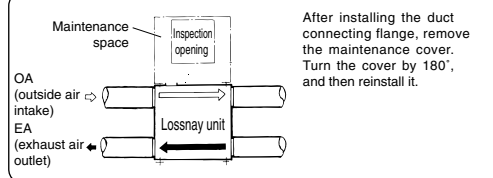

Electrically operated damper
(Protection against the intrusion of cold air while Lossnay is stopped in winter)
(To be provided by the customer)

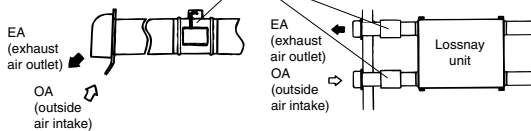

•In a region where there is risk of freezing in winter, it is recommended to install an Electrically operated damper, or the like, in order to prevent the intrusion of (cold) outdoor air while Lossnay is stopped.

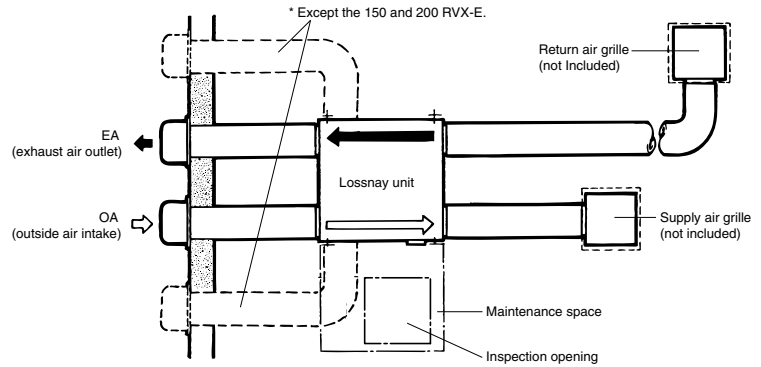

Downward gradient of duct:
1/30 or more (toward wall side) and provision of distance
in table below (to prevent rain water from seeping in)

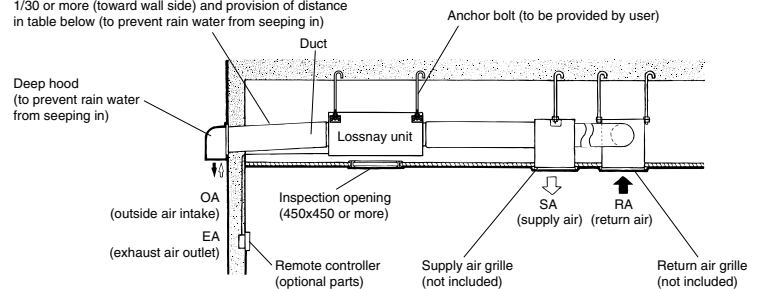

⚠ CAUTION

•Do not install Lossnay unit vertically or on an incline.

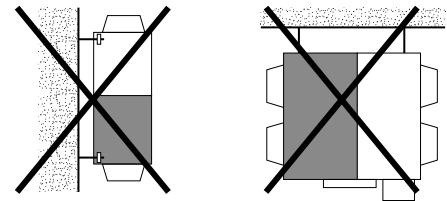

Attention for specifications

- Cold operation mode(*1) is to start repeating in the case that Lossnay's detected OA temperature is less than -10°C.
*1. Supply air(SA) in the operation for 60min. followed by stop operation for 10min.
- The current, power consumption and efficiency are based on the air flow rate in the specification.
- Fan speed is selectable by the remote controller from fan speed 1, 2, 3 and 4.
Multi Ventilation Mode should set on Lossnay unit or remote controller (PZ-61DR-E).
- Lossnay ventilation mode is to start automatically in the case that Lossnay's detected OA temperature is less than +8°C, even if Bypass ventilation is set by remote controller.
Remote controller continue to show "Bypass ventilation" in this case.
- Temperature Exchange efficiency(%) are based on winter condition.
- Mitsubishi Electric measures the machine according to the Japan Industrial Standards(JIS B 8628)

Attention

- When using the product where it is exposed to high temperatures and humidity (40°C or higher, RH 80% or higher), or where fog occurs frequently, moisture is likely to condense in the core, and may result in condensation build up in the unit. The product should not be used under such conditions.
- Outdoor air may enter the Lossnay owing to the pressure difference between indoor and outdoor or external winds even when the product is not operated. It is recommended to install an Electrically operated damper to block the outdoor air.
- In a cold weather area, an area with strong external winds or where fog occurs frequently, cold outdoor air, external winds or fog may be introduced into the product when its operation is stopped.
It is recommended to install an Electrically operated damper.
- In a cold weather area, or others, dewing or freezing could occur on the main unit, where the duct is connected, or other sections, depending on the conditions of outdoor air and indoor temperature and moisture, even if they are within the range of operating conditions. Make sure to confirm the operating conditions and other precautions, and do not use the product if dewing or freezing is anticipated.
- The outside ducts must be tilted at a gradient (1/30 or more) down toward the outdoor louvres from Lossnay, and properly insulated. (The entry of rain water may cause power leakage, fire, or damage to household property)
- The two outdoor ducts must be covered with heat-insulating material in order to prevent condensation from forming.
If it is expected that the ambient temperature around the place where the Lossnay unit is installed will be high during the summer air conditioning season, it is recommended that the indoor ductwork be covered with insulation material.
- Inspection opening (450 × 450 or more) must be installed on the filter and Lossnay core removing side.

Lossnay model selection advices

1. Operating environment
Install this product in an environment where the temperature ranges from -10°C to +40°C and the relative humidity is less than 80%RH. If condensation is expected to form, heat up the fresh outside air should be treated.
2. Do not use under high temperature and humidity condition
Condensation will occur and water will gather inside the Lossnay cores under high temperature and humidity condition, such as warm swimming pool, bathroom, greenhouse or foggy place.
3. Condition of outdoor, indoor and return air
Avoid using Lossnay under air condition with acid, alkalis, organic solvent, oil mist, paint, or harmful gas as pesticide, corrosive gas, etc.
4. Insulation failure caused by salt or sulphur air and hot spring steam, rust, fire or malfunction may occur.
Installing high quality filters inside outdoor air duct if the Lossnay operates in salt or sulphur air conditions.
5. Intake of mist or outdoor air during off-mode operation
Outdoor air or mist may flow through the duct into your room when Lossnay is in off-mode at windy and foggy area.
To prevent intake of outdoor air or fog, a damper is advised to be installed.
6. Entry of insects
When using the product in an environment where there is a window, or opening near the outdoor hood, so that insects are likely to gather around the interior or exterior light, take note that small insects may intrude into the Lossnay filters.
7. Bypass ventilation
In the case of "Bypass" ventilation, the supply air temperature slightly rises more than the outside air temperature because of the effect around the ducts or the unit motors.
8. Usage of M-NET.
When solely using Lossnay units, power supply unit is required to connect to centralized control.
Number of power supply units or the transmission boosters should correspond with the connected Lossnay units.

Caution for installation

1. Do not modify the unit as it may cause malfunction.
2. Do not install Lossnay unit vertically or on an incline. It may cause malfunction or deterioration of performance.
3. Leaving sufficient space for maintenance purpose.
4. The location of the air inlet
Take care in locating air inlet to prevent intake of dirty air or disgusting smell from exhaust gas of factory, air from rubbish disposal, etc.
5. Take precautions when using the product in a quiet location.
6. Heat insulation foam for duct
Take care as below to prevent the contaminate ceiling by duct condensation.
 - 1) The two outdoor ducts (OA and EA) must be covered with heat-insulating material in order to prevent condensation.
 - 2) If it is expected that the ambient temperature around the place where the Lossnay unit is installed will be high during the summer air conditioning season, it is recommended that the indoor ductwork should be covered with insulation material.
 - 3) Outdoor air may come into unit during not operating unit by the pressure difference between indoor and outdoor or the outdoor wind. In this case you should install a damper.
 - 4) It is possible for condensation and freezing to occur in the cold regions inside the unit because of the outdoor air condition or humidity condition above ceiling. Make sure to install supplemental insulation foam.
 - 5) In the case that air condition around Lossnay unit is high temperature in summer, it is recommended that there are heat insulation foam on indoor side duct to prevent heat recovery decreased by warming indoor duct. In winter, it is possible to cool indoor side duct without heat insulation foam on indoor side duct.
7. Prevent entry of rainwater into Lossnay unit
Install weather louver or "Weather cover" for OA inlet & EA outlet. This is to prevent rainwater entering the Lossnay unit. Ducts to outdoor (OA and EA) should decline by 1/30 or more.
8. Install the anchor bolts to ensure the product's weight or earthquake load. Correctly rated wire/chain may also be used.
9. Do not install this product in a place where it is exposed to ultraviolet light. UV may be damage covering insulation.
10. Electrical Work
A single pole isolator must be installed at the origins of mains power supply.
Use single flush box, to support remote controller.
Must connect ground wiring.
When connecting external devices (electrically operated damper, lamp, monitoring unit, etc.) using output signals of the Lossnay unit, make sure to install safety equipment for the external devices. (It could cause fire, damage, etc. without safety equipment)
11. Duct heater
In case of installing a duct heater interlock with Lossnay, be sure to observe followings.
 - 1) Select a duct heater in compliance with local and national laws, ordinances, and standards.
Select a duct heater that has obtained the CE mark.
 - 2) Always select a heater that is equipped with a non-self-resetting safety device.
Do not directly supply power from the Lossnay unit to the duct heater. Doing so could cause fire.
 - 3) Install a circuit breaker for the duct heater in compliance with all applicable laws, ordinances, and standards.
 - 4) Install the duct heater separated from the product by a distance of 2 m or more.
Failure to do so may result in equipment damage due to the transmission of residual heat from the heater.
 - 5) When using a heater without a temperature control function, select a heater with a capacity that is matched to the air volume.
 - 6) Do not use the heater outside the set air volume.
If the heater's capacity is too larger, this may result in the heater frequently turning ON/OFF.
If the heater's capacity is too small, this may result an inability to heat.
 - 7) Ensure that the duct heater and Lossnay are wired and that the Lossnay function settings have been configured, and then always check operation by trial operation.

Maintenance and lifetime

Refer to each model's operation instructions for the suggested maintenance period and methods. General indication of lifetime of the main parts is as below. Time below is unrelated to guaranteed period for service. And parts exchange period varies with usage condition.

Lossnay cores	: Around 10 years with maintenance as stated periods
Air Filters	: Around 5 years with maintenance as stated periods
High efficiency filters	: 3000 hours
Motor	: 30000 hours



for a greener tomorrow

Eco Changes is the Mitsubishi Electric Group's environmental statement, and expresses the Group's stance on environmental management. Through a wide range of businesses, we are helping contribute to the realization of a sustainable society.



mitsubishi electric corporation

HEAD OFFICE : TOKYO BLDG., 2-7-3 MARUNOUCHI, CHIYODA-KU, TOKYO 100-8310, JAPAN
www.MitsubishiElectric.com